



POLARIS
RANGER

2023

ACCESSORIES,
GARAGE & APPAREL

US VERSION

HARDEST WORKING.

SMOOTHEST RIDING.



For the past two decades, RANGER has set the standard through unrivaled strength, unmatched capability and next-level comfort, making it the number one utility side-by-side for over 10-years running.

2023 LINEUP

SEE THE FULL LINEUP AT POLARIS.COM/RANGER

1000 / XP 1000 / XP KINETIC

P. 16



RANGER 1000 EPS



RANGER 1000 PREMIUM



RANGER CREW 1000 PREMIUM



RANGER XP 1000 PREMIUM



RANGER CREW XP 1000 PREMIUM



RANGER XP KINETIC PREMIUM



RANGER XP KINETIC ULTIMATE



RANGER XP 1000 NORTHSTAR EDITION PREMIUM



RANGER CREW XP 1000 NORTHSTAR EDITION PREMIUM



RANGER XP 1000 NORTHSTAR EDITION ULTIMATE



RANGER CREW XP 1000 NORTHSTAR EDITION ULTIMATE



RANGER XP 1000 NORTHSTAR EDITION TRAIL BOSS



RANGER CREW XP 1000 NORTHSTAR EDITION TRAIL BOSS

SP 570

P. 68



RANGER SP 570



RANGER CREW SP 570



RANGER SP 570 PREMIUM



RANGER CREW SP 570 PREMIUM

570 FULL-SIZE

P. 88

YOUTH

P. 90



RANGER 570 FULL-SIZE



RANGER CREW 570 FULL-SIZE



RANGER 150 EFI

CONTENTS

1000 / XP 1000 / XP KINETIC 16

ROOFS	19
WINDSHIELDS	20
REAR PANELS	22
DOORS	24
CAB COMFORT & CONVENIENCE	26
WINCHES	28
PROTECTION	30
AUDIO	32
STORAGE	36

COMMON ACCESSORIES 42

CONNECTED TECHNOLOGY	42
ELECTRICAL ACCESSORIES	44
COOLERS	46
HUNT	48
COLD WEATHER	50
PLOWS	52
LIGHTING	56
WHEELS & TIRES	58

SP 570 68

ROOFS & DOORS	70
WINDSHIELDS & REAR PANELS	72
AUDIO & CONVENIENCE	74
PROTECTION & WINCHES	75
STORAGE	76

500 / EV / 570 78

ROOFS & DOORS	80
WINDSHIELDS & REAR PANELS	82
CONVENIENCE & PROTECTION	84
WINCHES	85
STORAGE	88

570 FULL-SIZE 88

YOUTH 90

PARTS & GARAGE 92

MAINTENANCE	92
OIL & LUBRICANTS	94
MAINTENANCE FLUIDS	96
GARAGE ACCESSORIES & BATTERY CHARGERS	98
HO PARTS	100
SERVICE PARTS	102
TIRE SEALANT & TRAILERING	104
POLARIS POWER	106

APPAREL 112

JERSEYS, GLOVES & HEATED APPAREL	114
HELMETS & GOGGLES	116
MEN'S APPAREL	118
BALL CAPS	122
CAMO APPAREL	123
WOMEN'S APPAREL	124
HOME & COLLECTIBLES	126

RANGER XP 1000 NORTHSTAR OFF-ROAD CLIMATE CONTROL

Be in control of your comfort with standard Pro Shield Cab System, heat, air conditioning, and more. Polaris RANGER NorthStar Editions help you finish whatever task you set out to do, no matter the weather conditions. Take your NorthStar to the next level with hundreds of accessories to choose from based on your riding needs.



DO MORE:

PROTECTION

Protect the front and rear of your RANGER from whatever obstacles you may encounter off-road.

P. 30

AUDIO

Customize your audio system to listen to your favorite songs on the trails.

P. 32

LIGHTING

Extend the day and work longer with easy-to-install powerful lighting.

P. 56

STORAGE

Leave nothing behind with the limitless customization of Lock & Ride storage.

P. 38

WHEELS & TIRES

Select wheels and tires custom built for your riding style and the terrain you ride in.

P. 58

UPGRADE YOUR NORTHSTAR RANGER XP 1000

You've got the essentials straight from the factory—but why stop there? Get the most out of your NorthStar with additional Polaris Engineered accessories to fit your riding needs. Add the **MUST HAVES** for top-selling accessories or **UTILITY** to optimize for the toughest outdoor jobs. Or, pick and choose your favorite accessories to make it your own.



NORTHSTAR ULTIMATE COMES STANDARD WITH:

Heating & Air Conditioning HVAC System
7" Display Powered by RIDE COMMAND
Pro Shield Full Glass Tip-Out Windshield with Wiper/Washer System
Power Window Doors
Polaris HD 4,500 lb. Winch with Auto-Stop
Sport Roof with Premium Liner & Dome Light
Lock & Ride Glass Panel
LED Headlights
29" Tires



NORTHSTAR PREMIUM COMES STANDARD WITH:

Heating & Air Conditioning HVAC System
Polaris HD 4,500 lb. Winch with Auto-Stop
Sport Roof with Premium Liner & Dome Light
Lock & Ride Glass Windshield with Wiper/Washer System
Lock & Ride Glass Rear Panel
Premium Manual Crank Window Doors

	PRODUCT NAME	PRODUCT NUMBER	PAGE
MUST HAVES	Front Brushguard	2882531 \$269**	P. 30
	Rear Brushguard	2882529 \$259**	P. 30
	Front Hood Storage Rack	2882090 \$379**	P. 38
	Lock & Ride Storage Box	2883279 \$249**	P. 41
	Polaris PULSE Wiring Harness - 1 Light Bar	2883200 \$94**	P. 45
	Pro Armor 33" - Combo LED Light Bar	2889791 \$379**	P. 57
		\$1,794**	
UTILITY	Side View Mirrors - Door Mounted	2889241 \$174**	P. 26
	Lock & Ride Bed Extender/Divider	2882752 \$259**	P. 38
	Electronic Cargo Box Lift	2884141 \$799**	P. 40
		PLUS \$1,294**	

TAKE ADVANTAGE
of your off-road climate control with winter and plow accessories on P. 52



DESIGNED by the people who designed your vehicle.



TESTED extensively in the field so you ride with 100% confidence.



TRUSTED 65 years in the business. The #1 name in Off-Road.



ACCESSORIES
BACKED BY A



WARRANTY

 **RHINO-RACK®**

Rhino-Rack® offers storage solutions designed specifically for Polaris RANGER. From opposite sides of the globe, some of the most capable machines in the off-road world meet a trusted outdoor adventure brand to deliver industry-exclusive, purpose-built roof racks, bed racks and accessories to help Polaris RANGER users have more fun and get more done. Designed for perfect integration and tested to off-road standards, a Rhino-Rack®-equipped RANGER will help you get more storage capacity out of your machine — so you can stay prepared for whatever the day may bring.



WE HOLD OUR PARTNERS TO THE SAME STANDARDS



UNLOCKING THE POWER OF EV CHARGING
P. 15



WHEELS, TIRES & LIGHTING DESIGNED WITH POLARIS TO MAXIMIZE PERFORMANCE
P. 57 & 58



IGNITE AND FUEL YOUR PASSION FOR PRECISE QUALITY SOUND REPRODUCTION
P. 32



PRODUCTS SO GOOD THEY REPLACE OR REPAIR THEM FOR LIFE
P. 56



DAVE TO LISTEN
P. 74



MAKING PRODUCTS FOR AVID SPORTSMEN SINCE 1943
P. 40



DIGITAL GAUGES FOR POWERSPORTS RIDERS
P. 43



BRING IT ALL. BRING IT ON.
P. 36

PURPOSE BUILT

FOR BIG WORK AND PLAY

The all-new 2023 RANGER XP 1000 NorthStar Trail Boss does more than just work hard, it sets the bar for heavy-duty capability. Trail Boss gives you the confidence, comfort and capability to do even more.



NEXT-LEVEL COMFORT

LEVERAGE THE FULL CAPABILITIES OF YOUR MACHINE YEAR-ROUND.

PRO SHIELD
CAB SYSTEM



SUPERIOR INTEGRATION

MAKE WORK EASIER WITH YOUR VEHICLE BUILT TO ADD ESSENTIAL ACCESSORIES FOR ANY JOB.

PRO PRO HEAVY DUTY SERIES

WINCHES

GLACIER
PLOW SYSTEM

POLARIS
PULSE
Electrical System



DO MORE

TACKLE ANY JOB AND LEAVE NOTHING BEHIND.

LOCK & RIDE

RHINO-RACK



ENGINEERED FOR MORE

POLARIS
ENGINEERED

HARDEST WORKING, SMOOTHEST RIDING.

RANGER is a trusted, most capable, work partner. Developed and tested along with the vehicle, Polaris Engineered Accessories are designed for seamless integration and simple installation to get more done, year-round.

SUPERIOR INTEGRATION



P. 49

PLUG AND PLAY ELECTRICAL

A revolution in electrical accessory integration, the Polaris PULSE Electrical System allows for a simple plug and play approach for adding power to Polaris Engineered Accessories.

PRO HEAVY DUTY SERIES WINCHES

RANGER 1000 / XP 1000 / XP KINETIC P. 28
RANGER SP 570 P. 75
RANGER 500 / EV / 570 P. 85
RANGER 570 FULL-SIZE P. 85

INTEGRATED WINCH MOUNT & PRE-WIRED

Designated mounting points and pre-wired connectors ensure a perfect fit and the strongest place to attach the Polaris Engineered winch - the most dependable winch for your RANGER. With wiring built right into the vehicle, we made this the easiest RANGER winch ever to install.

GLACIER PLOW SYSTEM

P. 52

INTEGRATED PLOW MOUNT*

The attachment points for the Glacier Plow System are integrated right at the factory and feature an innovative drive-up and go installation process.

*Integrated Plow Mount not included on RANGER SP 570 Non-Premium/Non-NorthStar Models



DO MORE

LOCK & RIDE

CARGO BOX VERSATILITY

Lock & Ride mounting locations allow for limitless customization to let you work the way you want.

RANGER 1000 / XP 1000 / XP KINETIC P. 38
RANGER SP 570 P. 76
RANGER 500 / EV / 570 P. 86

BRING IT ALL. BRING IT ON.

RHINO-RACK®

STORAGE VERSATILITY

Rhino-Rack® roof rack and bed rack solutions offer 40% more storage capacity so you never have to leave tools or gear behind.

RANGER 1000 / XP 1000 / XP KINETIC P. 36

NEXT-LEVEL COMFORT

OUR BEST SEALING CAB

With the profile channels engineered into the roll cage, body plastics molded to seal and cab accessories designed to keep the elements out, the Pro Shield Cab System offers a new level of interior comfort.

PRO SHIELD CAB SYSTEM

RANGER 1000 / XP 1000 / XP KINETIC P. 18
RANGER SP 570 P. 70

**PRO SHIELD
CAB SYSTEM**

NEXT-LEVEL COMFORT

Look for the Pro Shield Logo for the four components to customize your RANGER with our best sealing cab.

BUILD YOUR CAB SYSTEM

1 CHOOSE YOUR ROOF

RANGER 1000 P.18
XP 1000 P.19
XP KINETIC P.20
RANGER SP 570 P.21

2 CHOOSE YOUR WINDSHIELD

RANGER 1000 P.23
XP 1000 P.24
XP KINETIC P.25
RANGER SP 570 P.26

3 CHOOSE YOUR REAR PANEL

RANGER 1000 P.22
XP 1000 P.23
XP KINETIC P.24
RANGER SP 570 P.25

4 CHOOSE YOUR DOORS

RANGER 1000 P.26
XP 1000 P.27
XP KINETIC P.28
RANGER SP 570 P.29



ULTIMATE CLARITY

Tempered safety glass, clear to see through and shatterproof.

COLOR MATCHED

Key color matched accent panels available.

PROTECTION

Inner and outer shells are made from high-quality, injection-molded plastics using a state-of-the-art process to shield from the elements and more.

DURABLE CONSTRUCTION

With a 1" tube steel frame, these doors can handle the rigors of the off-road.



A FRAME DESIGNED FOR A CAB

All RANGER cab components fit perfectly to the contours of the profile tube cab frame, floor and body panels, allowing for a 360° gasket seal, seamless fit and installation providing unprecedented protection from the elements.

INCREASED RIDER COMFORT

Add a new level of interior comfort by adding a Pro Shield Cab System – tested to military standards. Seal out dust, water, and noise by selecting a roof, windshield, rear panel, and set of doors. Extend your work day or trail ride while protecting you and your passengers from the elements.



RAIN

Rest assured that you and your passengers will stay dry and comfortable on rainy days.



SNOW

Keep cold wind and snow out in winter months.



DUST

Reduce dust swirl in the cab of your RANGER for increased comfort and visibility.

SUPERIOR INTEGRATION

PRO PRO HEAVY DUTY SERIES

HD HEAVY DUTY SERIES



RANGER 1000 / XP 1000 / XP KINETIC P. 28
 RANGER SP 570 P. 75
 RANGER 500 / EV / 570 P. 85
 RANGER 570 FULL-SIZE P. 89

POLARIS ENGINEERED WINCH FEATURES



Tested **1,200+** pulls at max load, it works when you need it to



Built to withstand **-20° F** temperatures



Sealed motor & heavy duty gears
OPERATE FULLY SUBMERGED UNDERWATER



MILITARY tested & approved

Right from the factory, your vehicle is built to make essential accessories like winches and plows easy to use day-in and day-out. Mounting brackets are designed into the oversized factory bumper and wiring is routed securely and properly. When it comes to RANGER, Polaris Engineered Accessories make work easier so you can get more done.

POLARIS ENGINEERED

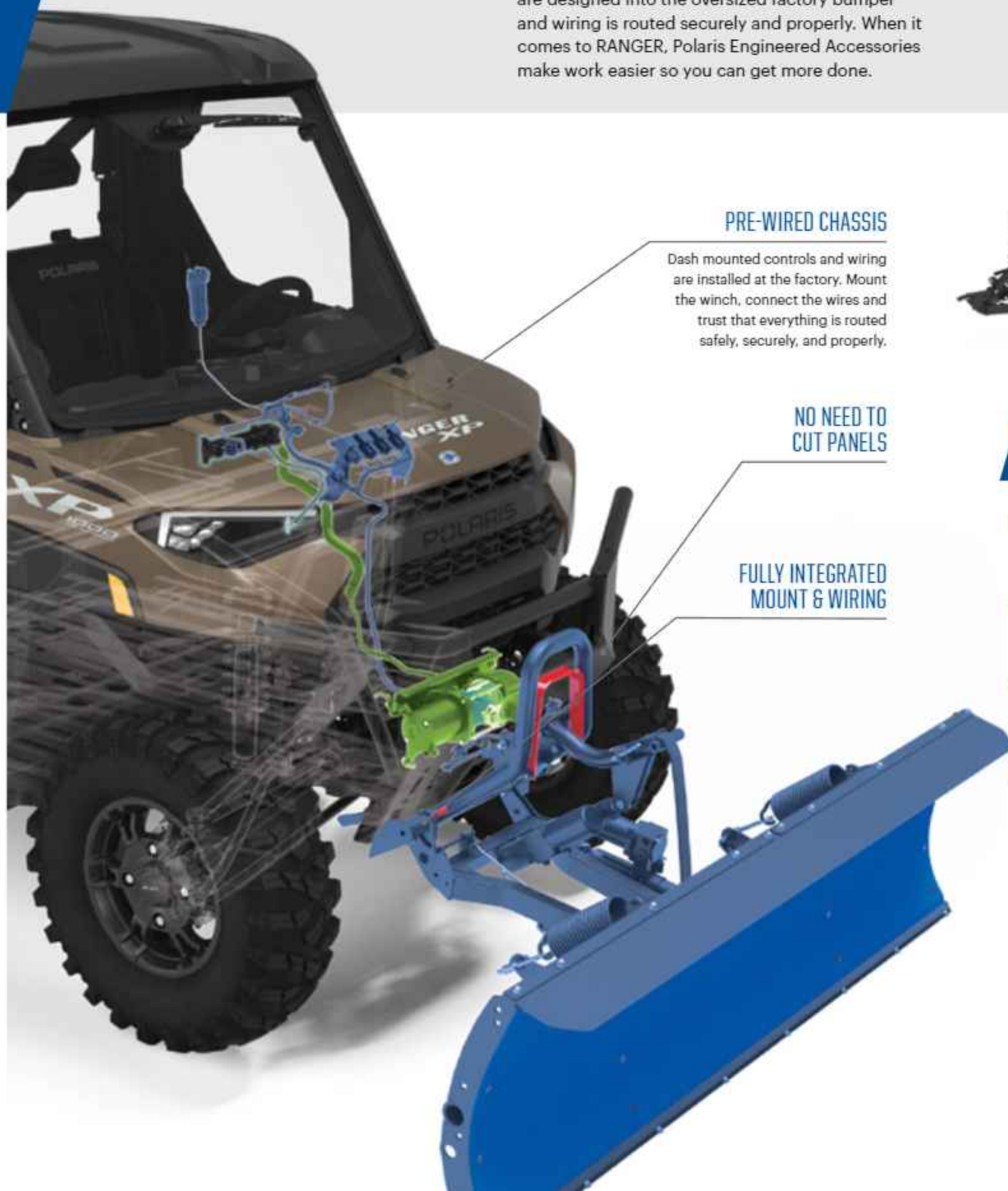

PRE-WIRED CHASSIS

Dash mounted controls and wiring are installed at the factory. Mount the winch, connect the wires and trust that everything is routed safely, securely, and properly.

NO NEED TO CUT PANELS

FULLY INTEGRATED MOUNT & WIRING

GLACIER PLOW SYSTEM

P. 52



GLACIER FEATURES

- ✓ To install the plow, simply lift the mount lock handle and pull forward
- ✓ No loss of factory ground clearance when not plowing
- ✓ Don't have to crawl under the machine to release the plow blade from the vehicle
- ✓ No trimming of vehicle plastic or fascia required to mount plow or winch

Angle your blade right from your seat

25°

LEFT AND RIGHT



RANGER XP KINETIC

THE POWER TO DO MORE



Do more than ever before with the full-size electric RANGER. Unmatched horsepower and instant torque means more power than ever before to precisely pull, haul more, and get more done. The industry's strongest drivetrain delivers lower maintenance costs and more uptime to get the job done. Plus, the quiet electric powertrain enables easy conversations while riding and stealthy trips to hunting spots.



RIDE COMMAND FRONT CAMERA

- Provides additional vantage point
- Front-mounted camera to help with plowing and other tasks

▶ 2889662 • \$129 ^{MSRP}
XP KINETIC '23



DUAL CHARGER HARNESS

- Required for installation of a 3kW On-Board Charger on XP Kinetic Premium trims

▶ 2889704 • \$599 ^{MSRP}
XP KINETIC '23



IN-CAB HEATER AND DEFROST KIT

- Easily control the climate inside your cab in any season
- Helps defrost windshields and keep you warm or cool
- Three different fan speeds
- Heat and fan dash-mounted controls
- Manual vents

▶ 2889449 • \$1,549 ^{MSRP}
XP KINETIC '23
REQUIRES HIGH VOLTAGE BUSBAR 2889667



ACCESSORY BUMPER HARDWARE

- Required when using a front camera as well as an upper front bumper or hood rack

▶ 2889659 • \$39 ^{MSRP}
XP KINETIC '23



TRIPLE CHARGER HARNESS

- Required for installation of a 3kW On-Board Charger on XP Kinetic Ultimate trims

▶ 2889486 • \$899 ^{MSRP}
XP KINETIC '23



3kW ON-BOARD CHARGER

- Provides additional 3kW charge so you can save time and get more done with your RANGER
- Increases charge rate while decreasing charge time when connected to appropriate in home charger for more efficiency
- Maximum charge of 6kW on Premium trims and 9kW on Ultimate trims
- Upgraded Level 2 EVSE + 240V outlet required for optimal charging for Ultimate trim with 9kW upgrade
- Pair with Wallbox® Pulsar Plus for optimal charging for Ultimate trim with 9kW upgrade

▶ 2889661 • \$799 ^{MSRP}
XP KINETIC '23
ULTIMATE TRIM: REQUIRES HIGH VOLTAGE BUSBAR 2889667 AND TRIPLE CHARGER HARNESS 2889486
PREMIUM TRIM: REQUIRES HIGH VOLTAGE BUSBAR 2889667 AND DUAL CHARGER HARNESS 2889704



HIGH VOLTAGE BUSBAR

- Required for adding heater or other high voltage accessories such as upgraded chargers

▶ 2889667 • \$299 ^{MSRP}
XP KINETIC '23



WALLBOX® PULSAR PLUS

- For RANGER XP Kinetic Ultimate trims only
- Achieve full charge in as little as 3.5 hours when paired with a 240V outlet

▶ 2890040 • \$649 ^{MSRP}
XP KINETIC '23
ULTIMATE TRIM ONLY

MAKE IT YOURS

WORK HARD AND GET IT DONE

with Polaris Engineered Accessories for your RANGER. Start with the ultimate in all-season performance and comfort with the best cab components in the industry. Find everything you need to outfit your RANGER for the task at hand.

RANGER 1000 / XP 1000 / XP KINETIC RANCH

2882910	Under Seat Dry Storage	P. 26	2882529	Rear Brushguard	P. 30
2882753	8-Vent Heater & Defrost System	P. 26	2882752	LOCK & RIDE Bed Extender/Divider	P. 38
2883265	Work Beacon LED Light	P. 27	2881531	LOCK & RIDE Tip-Down Headache Rack	P. 38
2882710	Polaris Pro HD 6,000 Lb. Winch with Rapid Rope Recovery	P. 29	2883121	RIGID® SR-Series 10" Spot LED Light	P. 56
2882531	Upper Front Brushguard	P. 30	2883148	Pro Armor Wheel & Tire Set: Dual Threat & 4202	P. 65

2882753	8-Vent Heater & Defrost System	P. 26	2884107	LOCK & RIDE Kolpin Rhino Grip Pro	P. 49
2883265	Work Beacon LED Light	P. 27	2889791	Pro Armor 33" - Combo LED Light Bar	P. 57
2882710	Polaris Pro HD 6,000 Lb. Winch with Rapid Rope Recovery	P. 29	2883157	Pro Armor Wheel & Tire Set: Attack 2.0 & 5202	P. 64
2882690	Front Hood Storage Rack	P. 38			

2882711	Polaris Pro HD 4,500 Lb. Winch with Rapid Rope Recovery	P. 29	2881533	LOCK & RIDE Tool Rack	P. 41
2882752	LOCK & RIDE Bed Extender/Divider	P. 38	2889791	Pro Armor 33" - Combo LED Light Bar	P. 57
2882751	Cargo Bed Mat	P. 40	2882384	Wheel & Tire Set: Pro Armor Harvester & 4202	P. 64
2879354	LOCK & RIDE Chainsaw Mount	P. 40			
2883279	LOCK & RIDE Storage Box	P. 41			

RANGER 1000 / XP 1000 / XP KINETIC WATERFOWL

2883265	Work Beacon LED Light	P. 27	2883263	In-Cab Gun Mount	P. 49
2882711	Polaris Pro HD 4,500 Lb. Winch with Rapid Rope Recovery	P. 29	2889794	Pro Armor 2"x2" Cube - LED Spot Light (x2)	P. 56
2882690	Front Hood Storage Rack	P. 38	2884271	Pro Armor Wheel & Tire Set: Mud XC & 4204	P. 64
2882177	LOCK & RIDE CargoMax System	P. 38			

2882711	Polaris Pro HD 4,500 Lb. Winch with Rapid Rope Recovery	P. 29	2881533	LOCK & RIDE Tool Rack	P. 41
2882752	LOCK & RIDE Bed Extender/Divider	P. 38	2889791	Pro Armor 33" - Combo LED Light Bar	P. 57
2882751	Cargo Bed Mat	P. 40	2882384	Wheel & Tire Set: Pro Armor Harvester & 4202	P. 64
2879354	LOCK & RIDE Chainsaw Mount	P. 40			
2883279	LOCK & RIDE Storage Box	P. 41			

RANGER 1000 / XP 1000 / XP KINETIC BIG GAME

2882753	8-Vent Heater & Defrost System	P. 26	2884107	LOCK & RIDE Kolpin Rhino Grip Pro	P. 49
2883265	Work Beacon LED Light	P. 27	2889791	Pro Armor 33" - Combo LED Light Bar	P. 57
2882710	Polaris Pro HD 6,000 Lb. Winch with Rapid Rope Recovery	P. 29	2883157	Pro Armor Wheel & Tire Set: Attack 2.0 & 5202	P. 64
2882690	Front Hood Storage Rack	P. 38			

RANGER 1000 / XP 1000 / XP KINETIC CRAFTSMAN

2882711	Polaris Pro HD 4,500 Lb. Winch with Rapid Rope Recovery	P. 29	2881533	LOCK & RIDE Tool Rack	P. 41
2882752	LOCK & RIDE Bed Extender/Divider	P. 38	2889791	Pro Armor 33" - Combo LED Light Bar	P. 57
2882751	Cargo Bed Mat	P. 40	2882384	Wheel & Tire Set: Pro Armor Harvester & 4202	P. 64
2879354	LOCK & RIDE Chainsaw Mount	P. 40			
2883279	LOCK & RIDE Storage Box	P. 41			

SHOP ALL RANGER ACCESSORIES AT
[POLARIS.COM/ShopRANGER](https://www.polaris.com/ShopRANGER)

COMPLETE LIGHTING WITH REQUIRED
LIGHT BAR HARNESSSES

SEE P. 56

ROOFS

POLY FEATURES

- Water run-off
- Liner ready
- Polaris PULSE plug and play
- Lightweight

TO SHIELD AGAINST DRIVING RAIN OR THE BLISTERING SUN, a roof is the first must-have of the Polaris Engineered cab components. Choose from poly or steel, and get on your way with protective peace of mind.



PREMIUM FINISH AND QUIETER RIDE



SEALED COVERAGE

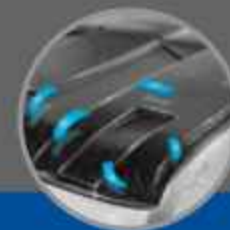

REDUCE STANDING WATER



EASY AND FAST INSTALLATION

POLARIS ENGINEERED ADVANTAGES

PREMIUM & SPORT ROOF FEATURES

SEE AUDIO OPTIONS P.32



* PREMIUM AND SPORT FEATURES NOT AVAILABLE ON STEEL ROOFS

MULTI-FUNCTION LIGHT READY

WINDSHIELD WIPER & WASHER SYSTEM WIRING READY

POLARIS PULSE INTEGRATION

AUDIO READY

SOUND ABSORBING LINER



POLY

Lightweight, durable and impact-resistant. A poly roof can take the abuse of a tough trail and still protect.

LINERS

Get a touch of premium comfort, reduce cab noise and hide wiring. Included with Premium Poly Roofs.

SPORT ROOF - POLY TOP YELLOW

• BLACK • 2882911 • **\$449** **
XP 1000 '17-23, 1000 '20-23, XP KINETIC '23



SPORT ROOF CREW - POLY TOP YELLOW

• BLACK • 2889223 • **\$699** **
CREW XP 1000 '19-23, CREW 1000 '20-23



PREMIUM ROOF LINER

• 2882914 • **\$214** **
XP 1000 '17-23, 1000 '20-23, XP KINETIC '23
WORKS WITH 2882911, 2882912, 2882913



PREMIUM ROOF LINER - CREW TOP YELLOW

• 2883457 • **\$349** **
CREW XP 1000 '19-23, CREW 1000 '20-23



PLUG AND PLAY

ADD POWER TO PREMIUM & SPORT ROOFS P.44

WINDSHIELDS

GLASS VS POLY

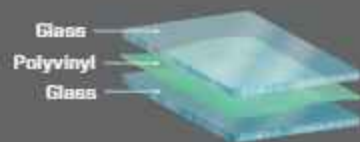

- Superior optical clarity (automotive level)
- Scratch-resistant
- Curved to fit, seals tight
- Cold weather / heavy duty
- Wiper ready

VS

- Lightweight, flexible, easy to store/remove
- Impact-resistant
- 360° seal keeps out rain and dust

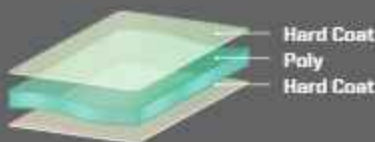

TIP-OUT FULL WINDSHIELD - GLASS

- Tip-out design offers three positions: open, closed and vented
 - Gas shocks assist in easy opening and closing
 - 360° gasket for reliable protection and comfort
 - Scratch-resistant automotive-style curved glass
- ▶ 2889020 • **\$1,399** ^{MS}
 XP 1000 '18-23, CREW XP 1000 '19-23, CREW 1000 '20-23, 1000 '20-23, XP KINETIC '23



FULL GLASS WINDSHIELD - CLEAR

- Scratch-resistant, curved laminate safety glass
 - Protects against wind, rain and other debris
 - UV-blocking interlayer and 360° gasket seal
- ▶ 2889021 • **\$829** ^{MS}
 XP 1000 '18-23, CREW XP 1000 '19-23, CREW 1000 '20-23, 1000 '20-23, XP KINETIC '23



LOCK & RIDE
EASY AND FAST
INSTALLATION



AIRTIGHT
GASKET SEAL



MULTI-FUNCTION
FEATURES

POLARIS ENGINEERED ADVANTAGES

HARD COAT POLY | 30x MORE SCRATCH-RESISTANT



LOCK & RIDE FULL WINDSHIELD VENTED - HARD COAT POLY ^{TOP SHELL}

- Frameless design for maximum visibility
 - Added vents for airflow on a hot day or defrosting on a cold day
 - Requires Wiper Install Kit, 2207624
- ▶ 2883266 • **\$649** ^{MS}
 XP 1000 '17-23, CREW XP 1000 '18-23, CREW 1000 '20-23, 1000 '20-23, XP KINETIC '23



LOCK & RIDE FULL WINDSHIELD - HARD COAT POLY ^{TOP SHELL}

- Frameless design for maximum visibility
 - Requires Wiper Install Kit, 2207624
- ▶ 2883300 • **\$569** ^{MS}
 XP 1000 '17-23, CREW XP 1000 '18-23, CREW 1000 '20-23, 1000 '20-23, XP KINETIC '23



FLIP-DOWN WINDSHIELD - HARD COAT POLY ^{TOP SHELL}

- Two venting options: fully sealed, flip-down or remove upper half for some protection with maximum ventilation
- ▶ 2884139 • **\$639** ^{MS}
 XP 1000 '18-23, CREW XP 1000 '19-23, CREW 1000 '20-23, 1000 '20-23, XP KINETIC '23



LOCK & RIDE FULL WINDSHIELD - POLY ^{TOP SHELL}

- Frameless design for maximum visibility
- ▶ 2883278 • **\$469** ^{MS}
 XP 1000 '17-23, CREW XP 1000 '18-23, CREW 1000 '20-23, 1000 '20-23, XP KINETIC '23



LOCK & RIDE HALF WINDSHIELD - POLY ^{TOP SHELL}

- Deflects air flow from straight on, but still provides air flow in the cab
- ▶ 2883301 • **\$249** ^{MS}
 XP 1000 '17-23, CREW XP 1000 '18-23, CREW 1000 '20-23, 1000 '20-23, XP KINETIC '23



ADD ALL-WEATHER VISIBILITY
WINDSHIELD WIPER
& WASHER SYSTEM
P. 26

HARD COAT POLY WINDSHIELD WIPER & WASHER MOUNTING BRACKET

- Required to use wiper on 2883266 or 2883300
- ▶ 2207624 • **\$59** ^{MS}
 XP 1000 '17-23, CREW XP 1000 '18-23, CREW 1000 '20-23, 1000 '20-23, XP KINETIC '23



REDUCE IN-CAB DUST
SWIRL BY ADDING A
REAR PANEL
SEE P. 22

REAR PANELS

GLASS VS POLY

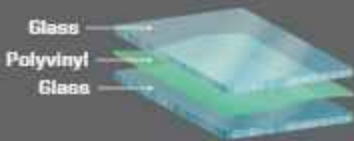

- Superior optical clarity (automotive level)
- Scratch-resistant
- Curved to fit, seals tight
- Cold weather / heavy duty
- Wiper ready (windshield only)

- Lightweight, flexible, easy to store/remove
- Impact-resistant
- Tight seal keeps out rain and dust

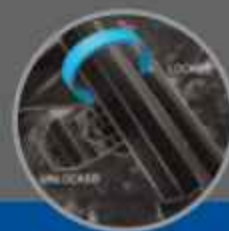
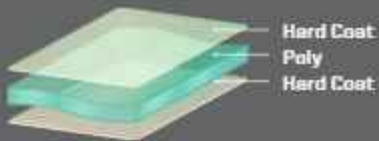

LOCK & RIDE
EASY AND FAST
INSTALLATION



**AIRTIGHT
GASKET SEAL**



**VENTING
OPTIONS**

POLARIS ENGINEERED ADVANTAGES



**REDUCE IN-CAB DUST SWIRL
BY ADDING A REAR PANEL**
With a windshield and roof installed, turbulent air develops behind the cab. Add a rear panel to reduce dust intrusion from this swirl.

HARD COAT POLY | 30x MORE SCRATCH-RESISTANT

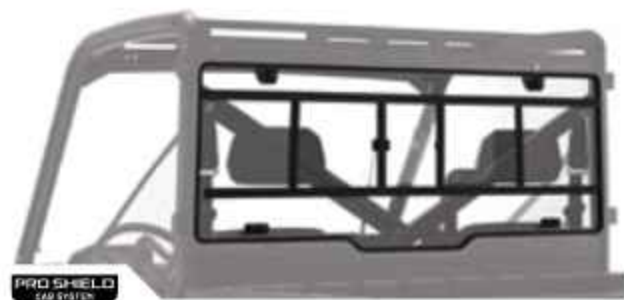

LOCK & RIDE
REAR PANEL - SLIDING GLASS

- Sliding window provides ventilation, cab comfort and access to cargo in rear box

▶ 2879015 • \$799 **
XP 1000 '17-23, CREW XP 1000 '18-23, CREW 1000 '20-23, 1000 '20-23, XP KINETIC '23



LOCK & RIDE
REAR PANEL - GLASS **TOP FILLER**

▶ 2879013 • \$499 **
XP 1000 '17-23, CREW XP 1000 '18-23, CREW 1000 '20-23, 1000 '20-23, XP KINETIC '23



LOCK & RIDE
REAR PANEL - POLY - CLEAR **TOP FILLER**

- Strong, thick polycarbonate provides outstanding impact and scratch resistance
- Installs in contours of cab frame with 360° gasketing for outstanding protection, comfort, fit and finish

▶ 2883773 • \$399 **
XP 1000 '17-23, CREW XP 1000 '18-23, CREW 1000 '20-23, 1000 '20-23, XP KINETIC '23

DOORS

THE BEST CAB

COMPLETED



SEE WHAT PEOPLE ARE SAYING ABOUT THESE DOORS
[YOUTUBE.COM/POLARISORV](https://www.youtube.com/polarisorv)
 SEARCH "DOORS"

KEY FEATURES	PREMIUM POLY DOORS			POLY DOORS		CANVAS DOORS
	POWER WINDOW DOORS	MANUAL CRANK WINDOW DOORS	HALF DOORS	RANGER HUNTER DOORS	RANGER CLEARVIEW DOORS	ZIP WINDOW DOORS
PRO SHIELD CAB SYSTEM						
WINDOW TYPE / VENTILATION	GLASS / POWER	GLASS / MANUAL CRANK	NA / OPEN TOP	GLASS / HINGED	GLASS / HINGED	CLEAR POLY / ZIPPED
VISIBILITY	UPPER	UPPER	UPPER	UPPER	UPPER + LOWER	UPPER + PARTIAL LOWER
STORAGE COMPARTMENT	STANDARD	STANDARD	STANDARD			
AUDIO-READY / SPEAKER MOUNT	STANDARD, PRE-WIRED	STANDARD				
PREMIUM TPE LINER	STANDARD	STANDARD	STANDARD			
SPECIAL FEATURES	BUILT-IN FLOOR LIGHT, COLORED ACCENT PANELS AVAILABLE	COLORED ACCENT PANELS AVAILABLE	COLORED ACCENT PANELS AVAILABLE	DURABLE POLY CONSTRUCTION, POLARIS PURSUIT CAMO	DURABLE POLY CONSTRUCTION	AVAILABLE IN POLARIS PURSUIT CAMO
	<ul style="list-style-type: none"> The ultimate door offering power windows, switches mounted on the door and built-in floor light. 	<ul style="list-style-type: none"> A premium, door offering manual crank windows for airflow adjustment in the cab. 	<ul style="list-style-type: none"> Provides lower protection from the off-road with an open-air experience. 	<ul style="list-style-type: none"> Tough clear poly shell extends from the bottom of the door until it meets the upper-hinged glass window. Premium Polaris Pursuit Camo pattern offers extensive camo coverage. 	<ul style="list-style-type: none"> Deliver nearly uninterrupted visibility and maximum ambient lighting inside the cab. Tough clear poly shell extends from the bottom of the door until it meets the upper-hinged glass window. 	<ul style="list-style-type: none"> Lightweight, durable protection with adjustable zipper ventilation and see-through bottom panel.

Front and Rear Doors are required to complete a cab on CREW RANGER models.

Premium Doors come with Gloss Black Exterior Door Accent Panels, images shown with optional Exterior Door Accent Panels.

FRONT DOORS (SET OF 2) XP 1000 '19-23, CREW XP 1000 '19-23, CREW 1000 '20-23, 1000 '20-23, XP KINETIC '23	FRONT DOORS (SET OF 2) CREW XP 1000 '19-23, CREW 1000 '20-23	REAR DOORS (SET OF 2) CREW XP 1000 '19-23, CREW 1000 '20-23	REAR DOORS (SET OF 2) CREW XP 1000 '19-23, CREW 1000 '20-23	REAR DOORS (SET OF 2) CREW XP 1000 '19-23, CREW 1000 '20-23	REAR DOORS (SET OF 2) CREW XP 1000 '19-23, CREW 1000 '20-23	REAR DOORS (SET OF 2) CREW XP 1000 '19-23, CREW 1000 '20-23	REAR DOORS (SET OF 2) CREW XP 1000 '19-23, CREW 1000 '20-23
<p>Power Window Doors - Poly - Black 2889813 • \$3,999**</p>	<p>Manual Crank Window Doors - Poly - Black 2889811 • \$3,249**</p>	<p>Half Doors - Poly 2889814 • \$1,799**</p>	<p>RANGER Hunter Doors - Polaris Pursuit Camo 2883229 • \$2,399**</p>	<p>RANGER ClearView Doors 2882901 • \$2,599**</p>	<p>Zip Window Doors - Canvas - Polaris Pursuit Camo 2882903 • \$1,309**</p>	<p>Zip Window Doors - Canvas - Black 2882902 • \$999**</p>	<p>Zip Window Doors - Rear - Canvas - Black 2883634 • \$999**</p>
<p>Manual Crank Window Doors - Rear - Poly 2889812 • \$3,249**</p>	<p>Half Doors - Rear - Poly 2889815 • \$1,899**</p>	<p>RANGER ClearView Doors - Rear 2883632 • \$2,599**</p>					

EXTERIOR DOOR ACCENT PANELS

• Replace stock gloss black accent panels

• Painted plastic and clear-coated for UV protection

• Install easily with a single screw

• Comes as a pair

FRONT REAR	<p>Super Graphite 2882870-509 • \$59** 2883829-509 • \$59**</p>	<p>Azure Crystal 2882870-809 • \$59** 2883829-809 • \$59**</p>	<p>Bronson Rock 2882870-755 • \$59** 2883829-755 • \$59**</p>	<p>Springfield Blue 2882870-640 • \$59** 2883829-640 • \$59**</p>	<p>White Lightening 2882870-599 • \$59** 2883829-599 • \$59**</p>	<p>Polaris Pursuit Camo 2882870-587 • \$104** 2883829-587 • \$104**</p>	<p>Pearl White 2882870-566 • \$59**</p>
FRONT REAR	<p>Solar Red 2883499-342 • \$59**</p>	<p>Black Pearl 2882870-666 • \$59**</p>	<p>Matte Sunset Red 2882870-669 • \$59**</p>	<p>Matte Sagebrush Green 2882870-685 • \$59** 2883829-685 • \$59**</p>	<p>Sunset Red Metallic 2882870-520 • \$59** 2883829-520 • \$59**</p>	<p>Matte Navy 2882870-726 • \$59** 2883829-726 • \$59**</p>	<p>Burgundy Metallic 2882870-629 • \$59**</p>
FRONT REAR	<p>Steel Blue 2882870-765 • \$59** 2883829-765 • \$59**</p>	<p>Ghost White Metallic 2882870-774 • \$59** 2883829-774 • \$59**</p>	<p>Polaris Blue 2882870-795 • \$59** 2883829-795 • \$59**</p>	<p>Stealth Gray 2882870-804 • \$59** 2883829-804 • \$59**</p>	<p>Onyx Black 2882870-866 • \$59**</p>	<p>Icy White Pearl 2882870-911 • \$79**</p>	

MORE COLOR OPTIONS AVAILABLE ONLINE AT
[RANGER.POLARIS.COM/DOORS](https://www.polaris.com/doors)

REQUIRED POLARIS PULSE
 INSTALLATION ITEMS



GET SUPERIOR PERFORMANCE AND OUR BEST SEAL with the Pro Shield Cab System door line

360° GASKET SEAL

EASY TO CLEAN TPE LINER

BUILT-IN STORAGE

AUDIO-READY

VENTILATION OPTIONS

CAB COMFORT & CONVENIENCE



POLARIS RANGER XP FULL-SIZE SEATSAVER - SPLIT BENCH SEAT XP 1000 ONLY

Covers the back and bottom of seat

- POLARIS PURSUIT CAMO • 2883244-587 • \$234 ^{MS}
 - CARHARTT BROWN • 2883244-218 • \$214 ^{MS}
 - CARHARTT GRAVEL • 2883244-458 • \$214 ^{MS}
- XP 1000 '18-'21, CREW XP 1000 '19-'21, XP KINETIC '23
CREW: FITS FRONT SEATS ONLY
NO REAR SEAT COVERS AVAILABLE



8-VENT HEATER & DEFROST SYSTEM

- Easily control the climate inside your cab in any season
- Helps defrost windshields and keeps you warm or cool
- Heat and fan dash-mounted controls
- Manual vents

- **TOP SELLER** 2882753 • \$1,199 ^{MS} XP 1000 ONLY
- XP 1000 '18-'23, CREW XP 1000 '19-'23
- **TOP SELLER** 2884066 • \$1,199 ^{MS} 1000 ONLY
- CREW 1000 '20-'23, 1000 '20-'23
- NEED ADAPTER: 2884163 ON CREW 1000
- **CREW HEATER ADAPTER KIT** 1000 ONLY
- 2884163 • \$104 ^{MS}
- CREW 1000 '20-'23



SIDE VIEW MIRRORS

- Mounts on any RANGER vehicle that is equipped with doors
- Fully adjustable to accommodate riders of all sizes and can fold in to prevent being struck
- **DOOR MOUNTED (shown)** • 2889241 • \$174 ^{MS}
- **ROPS-MOUNTED** • 2889243 • \$174 ^{MS}
- XP 1000 '18-'23, CREW XP 1000 '19-'23, CREW 1000 '20-'23, 1000 '20-'23, XP KINETIC '23



WINDSHIELD WIPER & WASHER SYSTEM

- 2883974 • \$589 ^{MS}
- XP 1000 '18-'23, CREW XP 1000 '19-'23, CREW 1000 '20-'23, 1000 '20-'23, XP KINETIC '23
- REQUIRES MOUNT KIT 2207624 FOR POLY WINDSHIELDS

HARD COAT POLY WINDSHIELD WIPER & WASHER SYSTEM MOUNTING BRACKET

- 2207624 • \$59 ^{MS}
- XP 1000 '17-'23, CREW XP 1000 '18-'23, CREW 1000 '20-'23, 1000 '20-'23, XP KINETIC '23
- REQUIRED TO USE WIPER ON 2883266 OR 2883300



LARGE REAR VIEW MIRROR TOP SELLER

- 2879969 • \$74 ^{MS}
- XP 1000 '17-'23, CREW XP 1000 '18-'23, CREW 1000 '20-'23, 1000 '20-'23, XP KINETIC '23



FLOOR MATS - 3 SEAT

- 2882780 • \$129 ^{MS} XP 1000 ONLY
- XP 1000 '18-'23, CREW XP 1000 '19-'23, XP KINETIC '23
- CREW: FITS FRONT SEATS ONLY
- 2884247 • \$129 ^{MS} 1000 ONLY
- CREW 1000 '20-'23, 1000 '20-'23
- CREW: FITS FRONT SEATS ONLY

NOISE REDUCTION SYSTEM

- 2883489 • \$279 ^{MS}
- XP 1000 '18-'23, CREW XP 1000 '19-'23, 1000 '20-'23, CREW 1000 '20-'23, XP KINETIC '23
- DESIGNED TO ATTACH TO THE REAR CLOSURE PANEL OF YOUR RANGER CAB, THE SOUND ABSORBING MATERIAL REDUCES UNWANTED NOISE FOR A QUIETER CAB



WIDE ANGLE REAR VIEW MIRROR

- Large 2.5" x 14" adjustable convex mirrored surface gives you a full-spectrum view
- 2881439 • \$139 ^{MS}
- XP 1000 '17-'23, CREW XP 1000 '18-'23, CREW 1000 '20-'23, 1000 '20-'23, XP KINETIC '23

UNDER SEAT DRY STORAGE XP 1000 ONLY

- 2882910 • \$349 ^{MS}
- XP 1000 '18-'23, CREW XP 1000 '19-'23, XP KINETIC '23
- WILL NOT WORK WITH SUBWOOFER 2882890 & 2884233



REMOTE GARAGE DOOR OPENER BY HOMELINK*

- Control up to two garage doors
- 2882892 • \$164 ^{MS}
- XP 1000 '18-'23, CREW XP 1000 '19-'23, CREW 1000 '20-'23, 1000 '20-'23, XP KINETIC '23



IN-CAB HEATER AND DEFROST KIT

- Easily control the climate inside your cab in any season
- Helps defrost windshields and keep you warm or cool
- Three different fan speeds
- Heat and fan dash-mounted controls
- Manual vents

- 2889449 • \$1,549 ^{MS}
- XP KINETIC '23
- REQUIRES HIGH VOLTAGE BUSBAR 2889667, SOLD SEPARATELY



12V CARGO BED POWER KIT*

- Additional power for your tools or accessories
- Requires 12V In-Bed Power Harness Extension (sold separately)

- 2889673 • \$299 ^{MS}
- XP 1000 '18-'23, CREW XP 1000 '18-'23, 1000 '20-'23, CREW 1000 '20-'23
- REQUIRES 12V IN-BED POWER HARNESS EXTENSION 2890068, SOLD SEPARATELY



12V IN-BED POWER HARNESS EXTENSION*

- Required for installation of 12V Cargo Bed Power Kit (2889673)

- 2890068 • \$49 ^{MS}
- CREW XP 1000 '18-'23, CREW 1000 '20-'23



UPPER SWITCH PANEL*

- Add up to 4 additional electrical accessory switches
- Convenient roof-mounted overhead panel
- Includes mounting hardware

- 2889674 • \$84 ^{MS}
- XP 1000 '18-'23, CREW XP 1000 '18-'23, 1000 '20-'23, CREW 1000 '20-'23
- REQUIRES UPPER SWITCH PANEL LIGHTBAR HARNESS 2889675, SOLD SEPARATELY



UPPER SWITCH PANEL LIGHTBAR HARNESS*

- Required for Upper Switch Panel Installation

- 2889675 • \$119 ^{MS}
- **EXTENSION** • 2890067 • \$29 ^{MS}
- XP 1000 '18-'23, CREW XP 1000 '18-'23, 1000 '20-'23, CREW 1000 '20-'23



WORK BEACON LED LIGHT

- 50 ft. of illumination 360° around your vehicle
- Ideal for plowing, hunting and nighttime utility work
- Break-away construction protects the light in areas with tight clearance
- Mounted to the vehicle on the rear of the ROPS
- Easily hinge the light up during use and hinge it down when in transit
- Add LED Headlights for more light

- 2883265 • \$279 ^{MS}
- XP 1000 '18-'23, CREW XP 1000 '19-'23, CREW 1000 '20-'23, 1000 '20-'23, XP KINETIC '23
- REQUIRES LIGHT BAR HARNESS/EXTENSION 2883230 AND 2883854, SOLD SEPARATELY



REAR LED WORK LIGHT

- Mounts to the back of your cab to fully illuminate the cargo box and surrounding area
- Includes necessary mounting hardware
- Requires a harness

- 2889672 • \$249 ^{MS}
- XP 1000 '18-'23, CREW XP 1000 '18-'23, 1000 '20-'23, CREW 1000 '20-'23



MULTI-FUNCTION CAB LIGHT

- LED dome light provides white, red, green and blue lighting options
- Battery-operated. Recharges when the vehicle is on
- Can be removed to use as a flashlight in and around your vehicle

- Red light is great for reading maps
- Green light is perfect for navigating in the dark
- Blue light is ideal for night riding

- 2882871 • \$129 ^{MS}
- XP 1000 '18-'23, CREW XP 1000 '19-'23, CREW 1000 '20-'23, 1000 '20-'23, XP KINETIC '23
- REQUIRES ROOF PULSE 2882904, SOLD SEPARATELY

LED HEADLIGHTS XP 1000 ONLY

- LED Headlights offer improved brightness and illumination vs stock halogen lights
- Designed with styling specific to RANGER

- 2889072 • \$514 ^{MS}
- XP 1000 '18-'23, CREW XP 1000 '19-'23, XP KINETIC '23



REVERSE WARNING ALERT

- 2883246 • \$59 ^{MS}
- XP 1000 '18-'23, CREW XP 1000 '19-'23, CREW 1000 '20-'23, 1000 '20-'23, XP KINETIC '23
- AUTOMATICALLY ACTIVATED WHENEVER THE VEHICLE IS PUT IN REVERSE

HORN TOP SELLER

- 2882764 • \$69 ^{MS}
- XP 1000 '18-'23, CREW XP 1000 '19-'23, CREW 1000 '20-'23, 1000 '20-'23, XP KINETIC '23



*Check with your local dealer for availability.



With Polaris PULSE it's easy to add all your electrical accessories. SEE P. 44 TO LEARN MORE

WINCHES

DEPENDABLE. TOUGH. BUILT FOR THE OFF-ROAD.

A Polaris Engineered winch is designed to help you get the job done right, get you on your way faster and prepare you for the unexpected.

WHY POLARIS?

Polaris off-road vehicles are engineered with designated mounting points and wiring for seamless install of Polaris Engineered winches.



TESTED **1,200+** PULLS AT MAX LOAD



BUILT TO WITHSTAND **-20° F** TEMPERATURES



OPERATES **FULLY SUBMERGED**



MILITARY TESTED & APPROVED

UPGRADE YOUR CONTROLS

DASH WINCH SWITCH KIT

- Allows user to add a dash switch as an additional means to control winch
- Can be used with all winches and are compatible with other control methods (wireless/wired)

2889050 • \$74⁹⁹

XP 1000 '18-23, CREW XP 1000 '19-23, CREW 1000 '20-23, 1000 '20-23, XP KINETIC '23

TRUCKER POWER CONTROLLER

- Control winch/plow hydraulics from shift knob

2883247 • \$214⁹⁹

XP 1000 '18-23, CREW XP 1000 '19-23, CREW 1000 '20-23, 1000 '20-23, XP KINETIC '23
REQUIRES WINCH ADAPTER 2884159 WHEN USING A WINCH FOR LIFTING DEVICE

WIRED REMOTE CONTROL

- Handle and socket both required

REMOTE HANDLE • 4013466 • \$68⁹⁹

SOCKET • 4017102 • \$69⁹⁹

WORKS WITH ALL MODELS

REPLACEMENT PARTS

SYNTHETIC ROPE

6,000 LB. 4,500 LB.
2879188 • \$184⁹⁹ 2879187 • \$139⁹⁹



ADD A PLOW
P. 54

FEATURES & BENEFITS

ALL POLARIS ENGINEERED WINCHES COME WITH:



WARRANTY

- ✓ INTEGRATED WIRING, MOUNT, PREASSEMBLED
- ✓ HOOK WITH STRAP
- ✓ CUT STEEL GEARS & SEALED DRIVETRAIN
- ✓ SEALED PERMANENT MAGNET MOTOR



Retrieve cable 5x as fast as standard mode on other Polaris winches. Get back to riding or complete your task quicker.

1. Set winch dial to N (Neutral) to manually pull the rope out and secure the hook to your anchor point.
2. Set winch dial to L (Low) for maximum pulling power while winching your load.
3. Set winch dial to H (High) for retrieving the rope 5x faster with Rapid Rope Recovery.

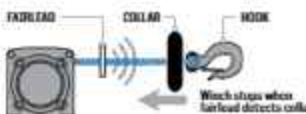

Auto Stop technology protects and extends the life of your winch by automatically stopping the winch at the end of pull to prevent over-spooling. While plowing, it prevents the plow frame from bending by stopping the winch once the plow has been lifted.



With its lightweight, yet extremely strong, design and superior flexibility, this 50 ft long synthetic rope is easy to handle and can stand up to any tough job.



This convenient remote operates your Polaris winch wirelessly from within 50 ft of the vehicle. Operate your winch safely outside your vehicle while on the job site or trails.

MODEL	6,000 LB.	4,500 LB.	4,500 LB.
XP 1000 '18-23 CREW XP 1000 '19-23 1000 '20-23 CREW 1000 '20-23 XP KINETIC '23 NON EPS RANGER 1000 REQUIRES FRONT BUMPER	TOP PICK 2882710 \$979 ⁹⁹	TOP PICK 2882711 \$899 ⁹⁹	TOP PICK 2882714 \$679 ⁹⁹

PRO PRO HEAVY DUTY SERIES

TOP-OF-THE-LINE FEATURES

BEST FOR PLOWING, HEAVY-DUTY OUTDOOR CHORES & TRAIL RIDING



PRO PRO HEAVY DUTY SERIES

HO HEAVY DUTY SERIES

BUILT FOR THE OFF-ROAD

BEST FOR THE CASUAL OFF-ROAD RIDER



HO HEAVY DUTY SERIES



NOT AVAILABLE



ADD AUTO STOP UPGRADE

2883454 • \$114⁹⁹

WORKS WITH 2882714
SYNTHETIC ROPE REQUIRED



ADD SYNTHETIC ROPE

2879187 • \$139⁹⁹



ADD WIRELESS REMOTE

2883455 • \$139⁹⁹

WORKS WITH 2882714

PROTECTION

PERFECT FOR: INCREASED PROTECTION AROUND LIGHTING AND FENDERS

STANDARD BRUSHGUARDS



FRONT

HD BRUSHGUARDS

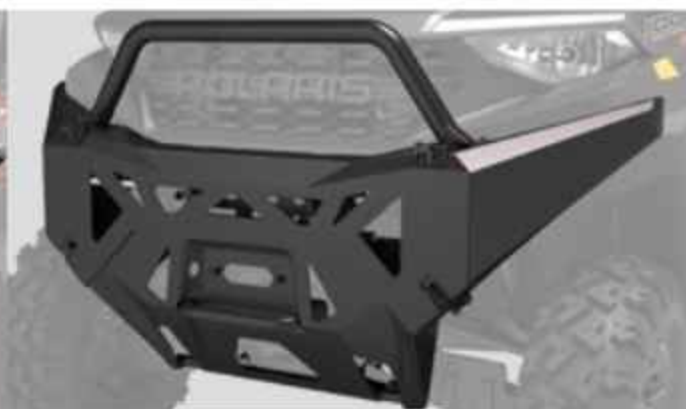

REAR



1 3/4" DIAMETER STEEL TUBE CONSTRUCTION

- To use Front Bumper with RIDE COMMAND and Front Camera, RIDE COMMAND Bumper Adapter (2207941) is required
- **TOP ROLLER FRONT** • 2882531 • \$269 ^{MS} ► **TOP ROLLER REAR** • 2882529 • \$259 ^{MS}
- XP 1000 '18-23, CREW XP 1000 '19-23, CREW 1000 '20-23, 1000 '20-23, XP KINETIC '23
FRONT BRUSHGUARD DOES NOT FIT HIGH LIFTER MODELS
1000 NON-EPS VEHICLES REQUIRE FRONT BUMPER: 2884123
- **RIDE COMMAND BUMPER ADAPTER** • 2207941 • \$39 ^{MS}
FOR USE ON VEHICLES WITH RIDE COMMAND AND FRONT CAMERA

- Increased protection over stock bumper with integrated mounting locations for accessories and lights (sold separately) with a durable matte black finish
- Easy installation with included mounting hardware
- Additional 36" storage area for recovery equipment
- **FRONT** • 2885105 • \$719 ^{MS} ► **REAR** • 2884217 • \$464 ^{MS}
- XP 1000 '18-23, CREW XP 1000 '19-23, CREW 1000 '20-23, 1000 '20-23, XP KINETIC '23
FRONT BRUSHGUARD DOES NOT FIT HIGH LIFTER MODELS
REAR: RECOMMENDED WITH RIGID® OR PRO ARMOR® POD LIGHTS FOR UPGRADED LIGHTING

HIGH-MOUNTED FRONT BRUSHGUARD



FRONT BRUSHGUARD 1000 ONLY



- Increased protection over stock bumper
- Offers a higher winch mounting position which allows for easier access when used in deep mud
- Not compatible with Polaris Plow Systems
- **2889271** • \$619 ^{MS}
- XP 1000 '18-23, CREW XP 1000 '19-23, CREW 1000 '20-23, 1000 '20-23, XP KINETIC '23

HIGH-MOUNTED HD 4,500 LB. WINCH

- Provides outstanding performance and versatile pulling power
- The elevated mounting position allows for easier access when used in deep mud
- **2889272** • \$749 ^{MS}
- XP 1000 '18-23, CREW XP 1000 '19-23, CREW 1000 '20-21, 1000 '20-23, XP KINETIC '23



- Increased protection over stock bumper
- Sturdy stamped steel and tube construction
- Integrated mounting positions for plow and winch accessories
- **2889330** • \$409 ^{MS}
- CREW 1000 '20-23, 1000 '20-23
REQUIRED TO INSTALL WINCH/PLOW ON NON EPS RANGER 1000

ACCESSORY BUMPER HARDWARE

- Required when using a front camera as well as an upper front bumper or hood rack
- **2889659** • \$39 ^{MS}
- XP KINETIC '23



ROCK GUARDS

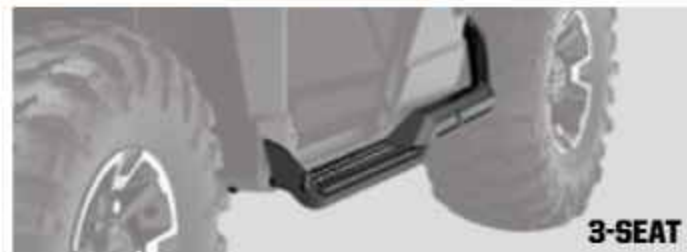

3-SEAT



CREW

ROCK GUARD WITH STEP

- Reliable, hard-working protection for edges of vehicle
- Integrated step with boot scraper helps keep interior clean
- Mounts directly to the frame, instead of underneath, for maximum ground clearance
- Steel construction with black e-coat and durable black powder-coated finish

- **TOP ROLLER 3-SEAT** • 2882530 • \$259 ^{MS} ► **CREW** • 2883398 • \$409 ^{MS}
- XP 1000 '18-23, 1000 '20-23, XP KINETIC '23 CREW XP 1000 '19-23, CREW 1000 '20-23

A-ARMS



HIGH CLEARANCE A-ARMS

- Valuable, reliable protection for vital front suspension components exposed to the rigors of off-road environments
- Strong, durable, lightweight polyethylene construction withstands off-road impacts to protect the A-Arms
- **FRONT** • 2889269 • \$369 ^{MS} ► **REAR** • 2889270 • \$369 ^{MS}
- XP 1000 '18-23, CREW XP 1000 '19-23, CREW 1000 '20-23, 1000 '20-23, XP KINETIC '23 XP 1000 '18-23, CREW XP 1000 '19-23, CREW 1000 '20-23, 1000 '20-23, XP KINETIC '23

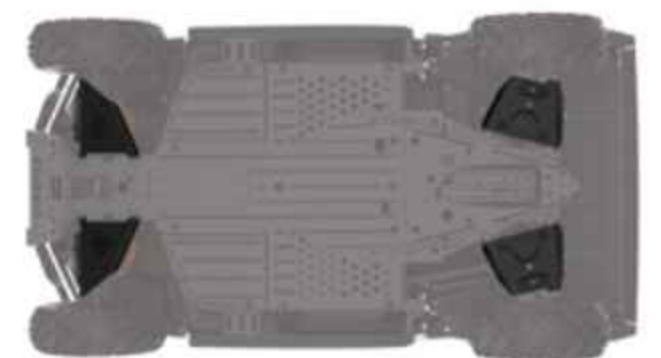

HMW A-ARM GUARDS

- Strong, 1/2" thick, durable, lightweight HMW (high molecular weight) polyethylene construction helps protect against off-road impacts
- Molded specifically for the RANGER XP 1000 & 1000 front suspension for a sure fit and low-profile presence
- Easy bolt-on design with mounting hardware included
- **FRONT** • 2882784 • \$214 ^{MS} ► **REAR** • 2882787 • \$214 ^{MS}
- XP 1000 '18-20, CREW XP 1000 '19-20, CREW 1000 '20, 1000 '20 WILL NOT FIT ARCHED A-ARM MODELS XP 1000 '18-23, CREW XP 1000 '19-23, CREW 1000 '20-23, 1000 '20-23, XP KINETIC '23 WILL NOT FIT ARCHED A-ARM MODELS

AUDIO

BUILD YOUR AUDIO SYSTEM

OFF-ROAD GRADE AUDIO

When you research audio solutions, you'll see manufacturers bragging about how their audio equipment is "Marine Grade". Or worse yet, you'll discover they are repackaged components built for automotive applications. MB Quart[®], combined with Polaris, engineers Off-Road Grade Audio equipment that's proven to deliver the loudest, crispest sound in the harshest conditions. Rain, snow, mud, heat, cold, dust—

ANY PLACE YOUR RANGER EXCELS, SO WILL YOUR AUDIO.

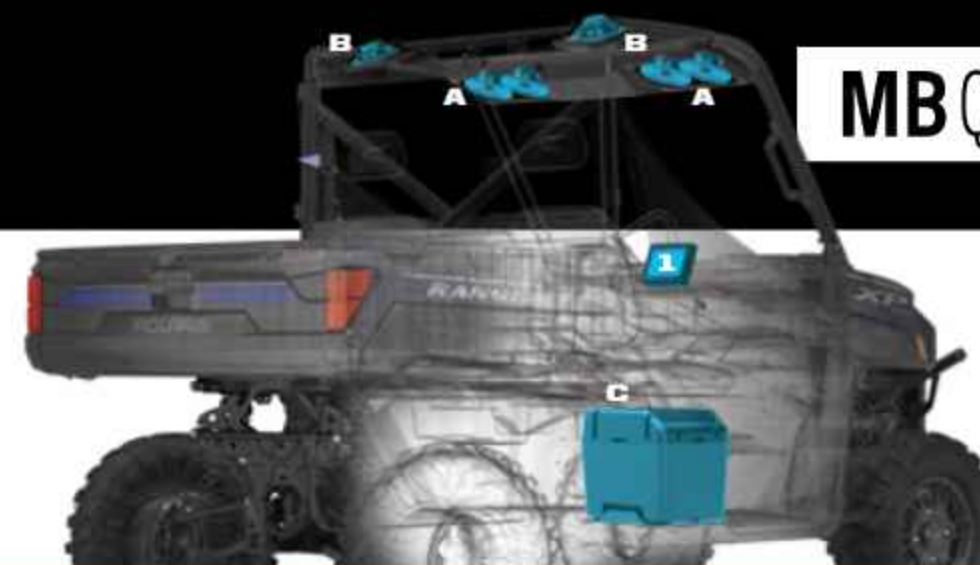

MBQUART

BUILD YOUR SOUND WITH RIDE COMMAND

STEP 1 ADD HEAD UNIT 7" DISPLAY POWERED BY RIDE COMMAND* 2884072 • \$1,594 ^{MS} <small>SEE P. 42 FOR MORE INFORMATION</small> <small>*Due to ongoing supply chain issues, there may be delayed or limited availability of this product as an accessory add on.</small>	STEP 2 ADD MOUNT 2889309 • \$514 ^{MS} <small>XP 1000 '22-'23, CREW XP 1000 '22-'23, CREW 1000 '22-'23, 1000 '22-'23, XP KINETIC '23</small> OR 2889310 • \$514 ^{MS} <small>XP 1000 '22-'23, CREW XP 1000 '22-'23, CREW 1000 '22-'23, 1000 '22-'23, XP KINETIC '23</small> <small>FOR NORTHSTAR AND ALL OTHER MODELS WITHOUT 500 WATT</small> <small>FOR 900 WATT STATOR</small>
---	---

STEP 3 UPGRADE AUDIO BY ADDING VISOR OR DASH AUDIO

**OPTION 1
VISOR AUDIO**

A. OVERHEAD VISOR SPEAKERS 2882891 • \$699 ^{MS} HARNES REQUIRED <small>TOP SELLER</small> 2882904 • \$104 ^{MS} <small>CREW MODELS REQUIRE ADDITIONAL 2883231</small>	+	B. REAR OVERHEAD SPEAKERS <small>TOP SELLER</small> 2882876 • \$249 ^{MS} <small>XP 1000 '19-'23, CREW XP 1000 '19-'23, CREW 1000 '20-'23, 1000 '20-'23, XP KINETIC '23</small>	+	C. 10" MAXBOOST SUBWOOFER 2884233 • \$699 ^{MS} <small>XP 1000 '18-'23, CREW XP 1000 '19-'23, XP KINETIC '23 WITH 900 WATT STATOR</small>
--	---	--	---	--

**OPTION 2
DASH AUDIO**

AUDIO DASH SPEAKERS <small>TOP SELLER</small> 2883956 • \$464 ^{MS} <small>XP 1000 '19-'23, CREW XP 1000 '19-'23, CREW 1000 '20-'23, 1000 '20-'23, XP KINETIC '23</small>	+	B. REAR OVERHEAD SPEAKERS <small>TOP SELLER</small> 2882876 • \$249 ^{MS} <small>XP 1000 '19-'23, CREW XP 1000 '19-'23, CREW 1000 '20-'23, 1000 '20-'23, XP KINETIC '23</small>	+	C. 10" MAXBOOST SUBWOOFER 2884233 • \$699 ^{MS} <small>XP 1000 '18-'23, CREW XP 1000 '19-'23, XP KINETIC '23</small> <small>RANGER MODELS WITH RIDE COMMAND PACKAGE REQUIRE 2883232 ADAPTER HARNES</small>
--	---	--	---	--

AUDIO DASH SPEAKERS INCLUDE BUILT-IN FOUR CHANNEL AMPLIFIER (40-WATTS) AND TWO OFF-ROAD GRADE 5.25" SPEAKERS

VISIT POLARIS.COM/SHOPRANGER FOR FITMENT FOR YOUR SPECIFIC MODEL & YEAR	DOWNLOAD THE RIDE COMMAND MOBILE APP 	CHECK FOR FEATURE ENHANCEMENTS & UPDATES AT POLARIS.COM/RIDECOMMAND
--	--	---

AUDIO

BUILD YOUR AUDIO SYSTEM

MBQUART®

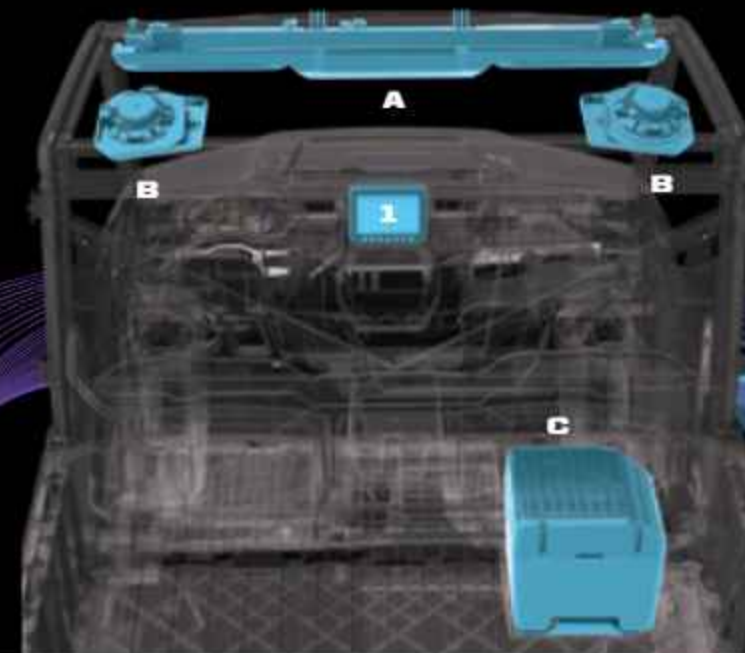

1 CHOOSE A HEAD UNIT Control all aspects of your sound system. Choose what to listen to and how loud.



160 WATT, WATERPROOF AM/FM BLUETOOTH® AUDIO SYSTEM IMPULSER



- All-in-one solution for giving your vehicle a performance-ready sound system
- USB input, Bluetooth® 4.0 compatible, Apple® Control, AM/FM tuner
- Built-in four channel amplifier (40-watts x 4)
- Two off-road grade 5.25" speakers with titanium dome tweeters and polypropylene cones

▶ 2882750 • \$679 ^{MS}
 XP 1000 '18-23, CREW XP 1000 '19-23, CREW 1000 '20-23, 1000 '20-23, XP KINETIC '23

USE AS IS OR ADD ADDITIONAL SPEAKERS



300 WATT AM/FM, BLUETOOTH® AUDIO VISOR WITH FOUR 6.5" WATERPROOF SPEAKERS IMPULSER



- One-step solution for off-road audio
- USB input, Bluetooth® 4.0 compatible, Apple® Control, AM/FM tuner
- 300-Watt four channel amplifier (75 watts x 4)
- Four 6.5" coaxial speakers with titanium dome tweeters and polypropylene cones
- Audio outputs to drive additional speakers
- Four Accessory knock outs

▶ 2882888 • \$899 ^{MS}
 XP 1000 '18-23, CREW XP 1000 '19-23, CREW 1000 '20-23, 1000 '20-23, XP KINETIC '23
 NOT COMPATIBLE WITH 7" DISPLAY POWERED BY RIDE COMMAND

COMES WITH OVERHEAD VISOR SPEAKERS (AT RIGHT) USE AS IS OR ADD ADDITIONAL SPEAKERS

2 ADD SPEAKERS - MIX AND MATCH

Your RANGER is ready for work, but is it ready to entertain? From a simple two-speaker setup to a complete system - add speakers to BUILD IT YOUR WAY.



STANDARD WITH VISOR STEREO

300 WATT OVERHEAD AUDIO VISOR SPEAKERS

- Built-in 300-Watt amplifier (75-watt x 4 channels)
- Four 6.5" speakers located in the overhead
- Waterproof system for reliable power and sound quality

▶ 2882891 • \$699 ^{MS}
 XP 1000 '18-23, CREW XP 1000 '19-23, CREW 1000 '20-23, 1000 '20-23, XP KINETIC '23



REAR OVERHEAD SPEAKERS IMPULSER

- Two 6.5" rear roof mounted speakers with titanium dome tweeters and polypropylene cones
- Easy Install
- Waterproof system for reliable power and sound quality

▶ 2882876 • \$249 ^{MS}
 XP 1000 '18-23, CREW XP 1000 '19-23, CREW 1000 '20-23, 1000 '20-23, XP KINETIC '23



MAX BOOST 10" 250 WATT SUBWOOFER RP 1000 ONLY

- Built-in 250-watt amplifier powering 10" waterproof subwoofer
- Fits RANGER XP 1000 with flip-up passenger seat

▶ 2882890 • \$699 ^{MS}
 XP 1000 '18-23, CREW XP 1000 '19-23, XP KINETIC '23
 NOT COMPATIBLE WITH 7" DISPLAY POWERED BY RIDE COMMAND, WILL NOT FIT WITH 2882900 STORAGE INSTALLED

3 MAKE IT WORK

VISOR STEREO HEAD UNIT

VISOR SPEAKERS

POLARIS PULSE ROOF 6

- Required with Visor Stereo (2882888)
- Required to add Visor Speakers (2882891)

▶ IMPULSER 2882904 • \$104 ^{MS}
 XP 1000 '18-23, CREW XP 1000 '19-23, CREW 1000 '20-23, 1000 '20-23, XP KINETIC '23

CREW MODELS

CREW EXTENSION

- Required for all Crew models where Polaris PULSE Roof 6 Harness (2882904) is required

▶ 2883231 • \$24 ^{MS}
 CREW XP 1000 '18-23, CREW 1000 '20-23

GEOFENCING KIT VIDEO ONLY

- Keep vehicle operators safe by quickly setting and controlling ride boundaries such as speed limits within and outside the geofenced area
- Ensure operators are riding at the appropriate speed for their experience and terrain by setting a max speed from your RIDE COMMAND app
- Activate passcode protection and to have full control of who and when the vehicle is being operated

▶ 2884779 • \$309 ^{MS}
 CREW 1000 '20-23, 1000 '20-23

1000 / XP 1000 / XP KINETIC

ROPS

WINDSHIELDS

REAR PANELS

DOORS

CAB COMFORT
B CONVENIENCE

WINCHES

PROTECTION

AUDIO

STORAGE

STORAGE

RHINO-RACK™

**BRING IT ALL.
BRING IT ON.**

From opposite sides of the globe, some of the most capable machines in the off-road world meet a trusted outdoor adventure brand to deliver industry-exclusive, purpose-built roof racks, bed racks and accessories to help Polaris RANGER users have more fun and get more done. Increase storage capacity so you can go where you want with everything you need, organized to succeed.



**MAXIMIZE
YOUR RIDE**

For decades, Rhino-Rack® has built some of the world's highest quality racks, accessories and mounts for the widest variety of uses and conditions. So whether you use your machine for hard work, hunting, fishing, and more, you can bring it all — and bring it on!



**BUILD THE ULTIMATE
UTILITY VEHICLE**

Transform your vehicle for work, play or anything in between with durable and easy-to-use roof and bed racks, load securing accessories and the latest in carrier technology.



**BUILT FOR
THE LONG HAUL**

Rhino-Rack® designs and builds award-winning racks, accessories and mounts to endure the most extreme uses and conditions.

PICK YOUR RACK



REAR BED RACK / 3-SEAT ROOF RACK

- Can be used as Bed Rack or Roof Rack on 3-Seat models, depending on which mount is purchased. Bed Rack only on Crew models.
 - Bed Rack and Roof Rack can be used together if both mounts are purchased
- ▶ 2889236 • \$514^{MS}
XP 1000 '18-'23, 1000 '20-'23, XP KINETIC '23



ROOF RACK - CREW

- ▶ 2889237 • \$514^{MS}
CREW XP 1000 '18-'23, CREW 1000 '20-'23

PICK YOUR MOUNT



REAR BED RACK MOUNT

- ▶ 2889235 • \$409^{MS}
XP 1000 '18-'23, 1000 '20-'23, CREW XP 1000 '18-'23, CREW 1000 '20-'23, XP KINETIC '23



ROOF RACK MOUNT

- ▶ 3-SEAT • 2889233 • \$409^{MS}
XP 1000 '18-'23, 1000 '20-'23, XP KINETIC '23
- ▶ CREW • 2889234 • \$409^{MS}
CREW XP 1000 '18-'23, CREW 1000 '20-'23

ACCESSORIZE IT



GUN MOUNTING BRACKET

- Bracket used to mount Kolpin Stronghold Gun Boots to Rhino-Rack® systems when paired with Auto-Latch Mount (2884106), sold separately
- ▶ 2889327 • \$54^{MS}
XP 1000 '18-'23, CREW XP 1000 '18-'23, CREW 1000 '20-'23, 1000 '20-'23, XP KINETIC '23

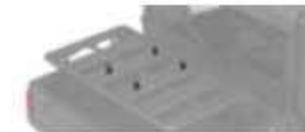

EYELET TIE-DOWNS

- Includes one set and hardware (straps not included) and attaches in multiple places on the platform to use as additional tie-down points
 - Anti-corrosive galvanized steel for heavy-duty strength and long life
- ▶ 2889527 • \$52^{MS}
XP 1000 '18-'23, CREW XP 1000 '18-'23, CREW 1000 '20-'23, 1000 '20-'23, XP KINETIC '23

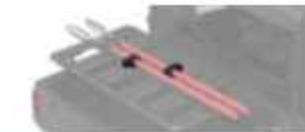

MULTI-PURPOSE TOOL HOLDER

- Carry and protect tools, paddles, and more during your ride
 - Ratchet-locking mechanism for quick release with rubber inserts to secure accessories into place
- ▶ 2889528 • \$111^{MS}
XP 1000 '18-'23, CREW XP 1000 '18-'23, CREW 1000 '20-'23, 1000 '20-'23, XP KINETIC '23

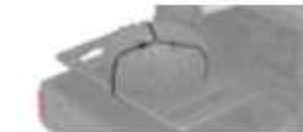

SPARE TIRE HOLDER

- Transport your spare tire outside your vehicle
 - Easily mounts to your Rhino-Rack® Rear Bed Rack
- ▶ 2889529 • \$45^{MS}
XP 1000 '18-'23, CREW XP 1000 '18-'23, CREW 1000 '20-'23, 1000 '20-'23, XP KINETIC '23



TRACTION BOARD MOUNT

- Strong, durable mount is easy to attach to the Rhino-Rack® platform
 - Traction board not included
- ▶ 2889530 • \$179^{MS}
XP 1000 '18-'23, CREW XP 1000 '18-'23, CREW 1000 '20-'23, 1000 '20-'23, XP KINETIC '23



CARGO CORNER BRACKET

- Bring your Polaris Northstar cooler along while saving space inside your vehicle
 - Unique anti-rotation nut for maximum cargo security
- ▶ 2889531 • \$129^{MS}
XP 1000 '18-'23, CREW XP 1000 '18-'23, CREW 1000 '20-'23, 1000 '20-'23, XP KINETIC '23

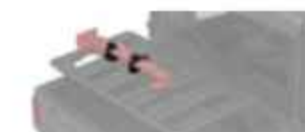

HIGH-LIFTING JACK MOUNT

- Installs simply and quickly with durable brackets
 - Rugged, non-corrosive powder-coated steel stands up to the harshest conditions
- ▶ 2889533 • \$112^{MS}
XP 1000 '18-'23, CREW XP 1000 '18-'23, CREW 1000 '20-'23, 1000 '20-'23, XP KINETIC '23



200L LUGGAGE BAG

- Carry your bulky, light weight gear while on the road in this tear-resistant and weather-resistant canvas bag
- ▶ 2889881 • \$224^{MS}
XP 1000 '18-'23, CREW XP 1000 '18-'23, CREW 1000 '20-'23, 1000 '20-'23, XP KINETIC '23

STORAGE



LOCK & RIDE

Exclusive to Polaris, Lock & Ride accessories let you quickly change from one task to another with hundreds of options.



WITH THE FLIP OF A LEVER, LOCK & RIDE PLUNGERS USE OUTWARD PRESSURE TO EXPAND FOR A SECURE FIT.



CARGO BED REAR WINCH



- Assists lifting heavy objects like hay bales or big game up into rear cargo bed
- 300 lb. winch mounts high on rear cab frame
- Equipped with 15 ft. of premium synthetic rope

2884215 • \$599 ^{MS}

XP 1000 '18-23, CREW XP 1000 '19-23, CREW 1000 '20-23, 1000 '20-23, XP KINETIC '23
REQUIRES ROOF PULSE: 2882904



LOCK & RIDE FRONT BRUSHGUARD STORAGE RACK

- Allows extra storage space in front of your vehicle
- Accommodates a Polaris Northstar 30 Quart Cooler or similar sized items
- Attaches and removes easily
- Mounts to existing plow mounting points

2883971 • \$309 ^{MS}

XP 1000 '18-23, CREW XP 1000 '19-23, CREW 1000 '20-23, 1000 '20-23, XP KINETIC '23



LOCK & RIDE TIP-DOWN HEADACHE RACK

- Rack tips down for additional storage solutions with space below and multiple tie-down points
- Lightweight and heavy-duty rack protects the cab of your RANGER and lets you haul even more.

2881531 • \$379 ^{MS}

XP 1000 '17-23, CREW XP 1000 '18-23, CREW 1000 '20-23, 1000 '20-23, XP KINETIC '23



LOCK & RIDE CARGOMAX SYSTEM

- Comes standard with a support bar that ties the two sides together for a sturdy cargo hold
- Designed to attach to the Lock & Ride Tip-Down Headache Rack for additional support and three-sided containment
- Adjustable utility hooks provide more options for hanging tools, cords or gear

2882177 • \$564 ^{MS}

XP 1000 '17-23, CREW XP 1000 '18-23, CREW 1000 '20-23, 1000 '20-23, XP KINETIC '23



FRONT HOOD STORAGE RACK

- Front curve helps keep cargo in place when traveling
- Provides additional protection
- Fully integrated pivots to gain under-hood access
- Requires Bumper Adapter 2207941 when used with 7" Display powered by RIDE COMMAND

2882690 • \$379 ^{MS}

XP 1000 '18-23, CREW XP 1000 '19-23, CREW 1000 '20-23, 1000 '20-23, XP KINETIC '23
DOES NOT FIT WITH BUMPER 2882531, REQUIRES 2207941 TO WORK WITH FRONT CAMERA



CANVAS STORAGE - CREW

- Attaches easily to the rear of the front seat in your crew vehicle
- Provides storage pockets for a variety of items, ensuring they're always within reach

2889268 • \$309 ^{MS}

CREW XP 1000 '18-23, CREW '20-23



LOCK & RIDE BED EXTENDER/DIVIDER

- Extend or divide the cargo box
- Installs in any location in the box
- Multiple tie-down points available to secure cargo

2882752 • \$259 ^{MS}

XP 1000 '18-23, CREW XP 1000 '19-23, CREW 1000 '20-23, 1000 '20-23, XP KINETIC '23

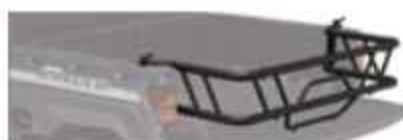

75+ COMBINATIONS TO MAKE IT YOUR OWN

With a full line of Lock & Ride accessories, you can haul more and do more. Use the chart below to see what combinations work together.

POLARIS RANGER STORAGE MATRIX 1000 / XP 1000 / XP KINETIC 570 FULL-SIZE	LOCK & RIDE Tip-Down Headache Rack ¹	LOCK & RIDE CargoMax System	LOCK & RIDE Bed Extender/Divider	LOCK & RIDE Storage Box	LOCK & RIDE Tool Rack	LOCK & RIDE Chairseat Mount	LOCK & RIDE 80 Gallon Boomless Utility Sprayer	Cargo Bed Rear Winch	LOCK & RIDE Front Brushguard Storage Rack	Cargo Bed Mat	RHINO-RACK Roof Rack - 3-Seat	RHINO-RACK Bed Rack - 3-Seat & Crew	RHINO-RACK Roof Rack - Crew
LOCK & RIDE Tip-Down Headache Rack ¹	2881531	2882177	2882752	2883279	2881533	2879354	2879799	2884215	2883971	2882751	2889236	2889236	2889237
LOCK & RIDE CargoMax System	✓	✓	✓	✓	✓	✓	✓	✓	✓	✓	✓	✓	✓
LOCK & RIDE Bed Extender/Divider	✓	✓	✓	✓	✓	✓	✓	✓	✓	✓	✓	✓	✓
LOCK & RIDE Storage Box	✓	✓	✓	✓	✓	✓	✓	✓	✓	✓	✓	✓	✓
LOCK & RIDE Tool Rack	✓	✓	✓	✓	✓	✓	✓	✓	✓	✓	✓	✓	✓
LOCK & RIDE Chairseat Mount	✓	✓	✓	✓	✓	✓	✓	✓	✓	✓	✓	✓	✓
LOCK & RIDE 80 Gallon Boomless Utility Sprayer	✓	✓	✓	✓	✓	✓	✓	✓	✓	✓	✓	✓	✓
Cargo Bed Rear Winch	✓	✓	✓	✓	✓	✓	✓	✓	✓	✓	✓	✓	✓
LOCK & RIDE Front Brushguard Storage Rack	✓	✓	✓	✓	✓	✓	✓	✓	✓	✓	✓	✓	✓
Cargo Bed Mat	✓	✓	✓	✓	✓	✓	✓	✓	✓	✓	✓	✓	✓
RHINO-RACK Roof Rack - 3-Seat	✓	✓	✓	✓	✓	✓	✓	✓	✓	✓	✓	✓	✓
RHINO-RACK Bed Rack - 3-Seat & Crew	✓	✓	✓	✓	✓	✓	✓	✓	✓	✓	✓	✓	✓
RHINO-RACK Roof Rack - Crew	✓	✓	✓	✓	✓	✓	✓	✓	✓	✓	✓	✓	✓

¹ Storage box at front of cargo box if not used with Tip-down Headache Rack

² Storage box at front of cargo box

LOCK & RIDE QUICKSTRAP

- The quickest and most secure way to mount Polaris accessories
- Sold as a pair

2882187 • \$44 ^{MS}

ALL COOLERS, RANGER CARGO BOXES



LOCK & RIDE D-RINGS

- The most versatile Lock & Ride accessory - add as many as you need to secure your cargo with bungee cords or straps

2881545 • \$34 ^{MS}

ALL RANGER CARGO BOXES



1.5" x 15' 5,500 LB RATCHET STRAP

- Heavy-duty webbing
- 5,500 lb. maximum load / 1,833 lb. working load
- 2 Pack

2884031 • \$44 ^{MS}

2" x 20' 10,000 LB RATCHET STRAP

- Heavy-duty webbing
- 10,000 lb. maximum load / 3,300 lb. working load
- Floating D-Rings and Double J-Hooks

2884032 • \$94 ^{MS}

STORAGE

LOCK & RIDE CHAINSAW MOUNT

- Can be secured to the outside of the bed wall so your chainsaw is within reach at all times

▶ 2879354 • \$139 **

XP 1000 '17-23, CREW XP 1000 '18-23, CREW 1000 '20-23, 1000 '20-23, XP KINETIC '23



LOCK & RIDE 60 GALLON BOOMLESS UTILITY SPRAYER

▶ 2879799 • \$959 **

XP 1000 '17-23, CREW XP 1000 '18-23, CREW 1000 '20-23, 1000 '20-23, XP KINETIC '23



BED ESSENTIALS

FIRE EXTINGUISHER HOLDER

- Only holds a 3.25" diameter extinguisher
- Quick release strap allows for easy use

▶ 2882158 • \$89 **

XP 1000 '17-23, CREW XP 1000 '18-23, CREW 1000 '20-23, 1000 '20-23, XP KINETIC '23



ELECTRONIC CARGO BOX LIFT

▶ 2884141 • \$799 **

XP 1000 '18-23, CREW XP 1000 '19-23, CREW 1000 '20-23, 1000 '20-23, XP KINETIC '23



RIDE & REPAIR ESSENTIALS KIT

▶ 2881207 • \$109 **

XP 1000 '17-23, CREW XP 1000 '18-23, CREW 1000 '20-23, 1000 '20-23, XP KINETIC '23



CARGO BED MAT

- Non-slip surface to better secure loads and keep cargo bed clean

▶ 2882751 • \$139 **

XP 1000 '18-23, CREW XP 1000 '19-23, CREW 1000 '20-23, 1000 '20-23, XP KINETIC '23



TOW & HAUL



TRAILER BALLS

▶ 2" WITH 3/8" SHANK 2877603 • \$14 **

▶ 1 1/2" WITH 3/8" SHANK 2877602 • \$14 **



2" BALL MOUNT

▶ 2" RECEIVER 2875320 • \$44 **



3:1 HITCHES

▶ 2" x 2" RECEIVER 2830522 • \$39 **

▶ 1 1/2" x 1 1/4" RECEIVER 2830523 • \$39 **

ALL RANGER MODELS



▶ 1 1/2" REPLACEMENT BALL 2830524 • \$9 **

ALL RANGER MODELS



NEW FRONT RECEIVER HITCH

▶ 2" WITH 3/8" SHANK 2884692 • \$129 **

ALL RANGER MODELS



TASK-SPECIFIC TOOLS

LOCK & RIDE TOOL RACK

- Attach on the inside or outside of the cargo bed

▶ 2881533 • \$259 **

XP 1000 '17-23, CREW XP 1000 '18-23, CREW 1000 '20-23, 1000 '20-23, XP KINETIC '23



ORGANIZE & PROTECT

LOCK & RIDE STORAGE BOX

- Enough room to store all the tools you need to get the job done
- Internal organizational dividers keep gear from rolling around
- Easily detaches from vehicle

▶ 2883279 • \$349 **

XP 1000 '17-23, CREW XP 1000 '18-23, CREW 1000 '20-23, 1000 '20-23, XP KINETIC '23



DO MORE:



COOLERS
P. 46



HUNT
P. 48



COLD WEATHER
P. 50



LIGHTING
P. 56

CONNECTED TECHNOLOGY

ENHANCE YOUR RIDE.



POLARIS RIDECOMMAND

PLAN YOUR RIDE

Plan an epic ride with stops along the way, customize and adjust your path to maximize your route or follow turn-by-turn directions. You can even share your planned route with friends.

FOLLOW THE GROUP

With Group Ride, you can ride at your own speed and keep fellow riders in sight on your map screen, even if you get split up. Because rides are meant to be shared.

WORK SMARTER

Plow Mode automatically raises and lowers the plow depending on the gear you're in, so that you can get your work done quicker.

DISCOVER NEW TRAILS

With over 1,000,000 miles of trails available offline, you'll have the confidence to explore further, whether you have cellular coverage or not.

AVAILABLE ON RIDE COMMAND MODELS & AS AN ACCESSORY

7" DISPLAY POWERED BY RIDE COMMAND*

- **Bright, 7" touchscreen** visible in all conditions
- **Camera Integration** Navigate with full view of your surroundings. Use the integrated rear camera to see others behind you while riding.
- **Personalized Audio Experience** Seamlessly pair your display via Bluetooth* to wirelessly stream music and stay connected with call and text alerts.

▶ **2884072 • \$1,594****
XP 1000 '19-'23, CREW XP 1000 '19-'23, CREW 1000 '20-'23, 1000 '20-'23, XP KINETIC '23
SPEAKERS NOT INCLUDED. MUST CHOOSE AUDIO PACKAGE FOR AUDIO OUTPUT

- **Configurable Gauges** Customize your ride experience with elevation, travel direction, fuel level and more to create relevant screens for you.
- **Plow Mode** Included on XP 1000 '18-'20 and CREW XP 1000 '19-'20 models (see P. 50 for details).



7" DISPLAY MOUNT KIT

- Necessary mount for your 7" Display Powered by RIDE COMMAND
- Seamless fit and finish
- Includes necessary wiring harness and reverse camera kits

▶ **2889309 • \$514****
XP 1000 '22-'23, CREW XP 1000 '22-'23, CREW 1000 '22-'23, 1000 '22-'23
FOR NORTHSTAR AND ALL OTHER MODELS WITHOUT 900 WATT

▶ **2889310 • \$514****
XP 1000 '22-'23, CREW XP 1000 '22-'23, CREW 1000 '22-'23, 1000 '22-'23, XP KINETIC '23
FOR 900 WATT STATOR

▶ **2889163 • \$499****
SP 570 '22-'23

FRONT CAMERA KIT

▶ **2889662 • \$129****
XP KINETIC '23, SEE FULL DETAILS ON P. 15



	POLARIS RIDECOMMAND	POLARIS RIDECOMMAND+
VEHICLE OWNERSHIP	GARAGE	✓
	WARRANTY STATUS	✓
	MAINTENANCE TRACKING	✓
	ISSUE DIAGNOSTIC	✓
	VEHICLE HEALTH	✓
RIDING FEATURES	COMMUNITY	✓
	CONTENT SHARING	✓
	RIDE PLANNING	✓
	WAYPOINTS	✓
	RIDE TRACKING	✓
SECURITY	RIDE TRACKING+	✓
	GROUP RIDE	✓
	GROUP RIDE+	✓
	VEHICLE LOCATOR	✓
	LOCATION ALERTS	✓
BUMP ALERT	✓	

LEARN MORE AND DOWNLOAD AT RIDECOMMAND.POLARIS.COM



POLARIS INTRODUCING RIDECOMMAND+

THE LATEST IN INDUSTRY-LEADING CELLULAR TECHNOLOGY CONNECTING YOU TO YOUR VEHICLE

Vehicle location and health in the palm of your hand. Over the air updates with new feature releases.

PLUG-IN** AVAILABLE ON SELECT 2023 MODELS

- **Vehicle Locator** Pinpoint exactly where your vehicle is at any time, on or off your property. Using the Polaris App powered by RIDE COMMAND, the vehicle locator gives you the peace of mind that you will be able to get back your ride.
- **Vehicle Health** Before you head out, log in using the Polaris App to remotely check on the readiness of your ride for the day you have planned. Monitor gas or charge level of your vehicle, battery condition, estimated range and oil change status for a confident start to the day.
- **Bump Alert** Coming Soon! Protect your investment by keeping tabs on it 24/7. Receive a notification if your vehicle has been bumped or moved from its last location and track.
- **Ride Tracking+** Coming Soon! Map the details of your entire ride automatically including route, average speed, time elapsed, elevation changes and more. You can even save tracked rides and go back to your favorite spots or share with your friends.

▶ **PLUG-IN • 2890038 • \$299****
XP 1000 '23, CREW XP 1000 '23, CREW 1000 '23, 1000 '23, SP 570 '23, CREW SP 570 '23

▶ **INSTALL KIT • 2889602 • \$69****
XP 1000 '23, CREW XP 1000 '23, CREW 1000 '23, 1000 '23
REQUIRED IN ADDITION TO 2890038

▶ **INSTALL KIT • 2889873 • \$79****
SP 570 '23, CREW SP 570 '23
REQUIRED IN ADDITION TO 2890038

**Check with your local dealer for availability.



LEARN MORE AT TRAILTECH.NET

VOYAGER PRO KIT, UTV

- **Bright, 4" touchscreen** visible in all conditions
- **Compatible with RIDE COMMAND**
- **Pre-Loaded Base Maps** The map screen is enabled with base maps, topography lines, hill shading and select trails. Record or load GPS trails/riding areas and transfer to a PC.
- **Buddy Tracking** Track up to 20 group members no matter what type of vehicle they are riding.
- **Bluetooth* Enabled** Bluetooth* enabled for intercom, phone and media controls. Play songs from your phone or MicroSD card using a Bluetooth* headset, speaker or intercom. Two phones and two headsets can be connected at the same time.

▶ **922-125 • \$649****
AVAILABLE AT YOUR LOCAL DEALER OR ONLINE AT TRAILTECH.NET

*Due to ongoing supply chain issues, there may be delayed or limited availability of this product as an accessory add on.

COMMON ACCESSORIES
CONNECTED TECHNOLOGY
ELECTRICAL ACCESSORIES
COOLERS
LIGHTS
COLD WEATHER
PLUMBS
LIGHTS

ELECTRICAL ACCESSORIES

Polaris PULSE is a revolutionary way to provide additional power locations on your vehicle, and makes adding electrical accessories a snap. Electrical accessories are easier to install on the roof, with designated routing areas and plug and play connections.

Look for  to identify Polaris PULSE ready accessories.

ADD ELECTRICAL SYSTEM ACCESSORIES IN 4 EASY STEPS

STEP 1	1000 / XP 1000 / XP KINETIC	CREW 1000 / XP 1000	SP 570	CREW SP 570
CHOOSE A POLARIS PULSE READY ROOF				
Premium Roof - Poly - Polaris Pursuit Camo	2882913 \$749 ^{MS}	N/A	N/A	
Premium Roof - Poly - Black	2882912 \$659 ^{MS}	N/A	N/A	
Sport Roof - Poly - Black	2882911 \$449 ^{MS}	2889223 \$699 ^{MS}	2885077 \$419 ^{MS}	2885078 \$679 ^{MS}

THE FOLLOWING ACCESSORIES EASILY PLUG INTO THE FACTORY INSTALLED POLARIS PULSE UNDER THE HOOD:

	1000 / XP 1000	XP KINETIC	SP 570
8-Vent Heater & Defrost System	P. 26	P. 15	P. 74
Horn	P. 27	P. 27	P. 74
Plow Controller	P. 28	P. 28	P. 75
150 Watt, Waterproof AM/FM Bluetooth® Audio System	P. 32	P. 32	P. 74
Light Bars	P. 56	P. 56	P. 56



POLARIS PULSE UNDERHOOD BUS BAR - 6 POSITION 1000 ONLY

• If upgrading to more than three accessories attaching to the underhood PULSE location, replace 3-Position Bus Bar with the Polaris PULSE Underhood Bus Bar - 6 Position

▶ 2884183 • \$44^{MS}

CREW 1000 '20-23, 1000 '20-23

POLARIS FRONT PULSE BAR AND HARNESS

• This kit is required to install any electrical accessories on a base RANGER SP 570

▶ 2889185 • \$84^{MS}

SP 570 '22-23

POLARIS PULSE BATTERY TENDER ADAPTER

• Connects your BatteryMINDER® or trickle charger to your vehicle

▶ 2884287 • \$24^{MS}

XP 1000 '19-21, CREW XP 1000 '19-23, CREW 1000 '20-23, 1000 '20-23, SP 570 '22-23, CREW SP 570 '22-23, XP KINETIC '23

STEP 2	1000 / XP 1000 / XP KINETIC	CREW 1000 / XP 1000	SP 570	CREW SP 570
ADD THE POLARIS PULSE ROOF &				
Polaris PULSE Roof &		2882904 \$104 ^{MS}		
Polaris PULSE Wiring Harness - Crew Extension	N/A		2889185 \$84 ^{MS}	

POLARIS PULSE READY ROOF WIRING EXAMPLE

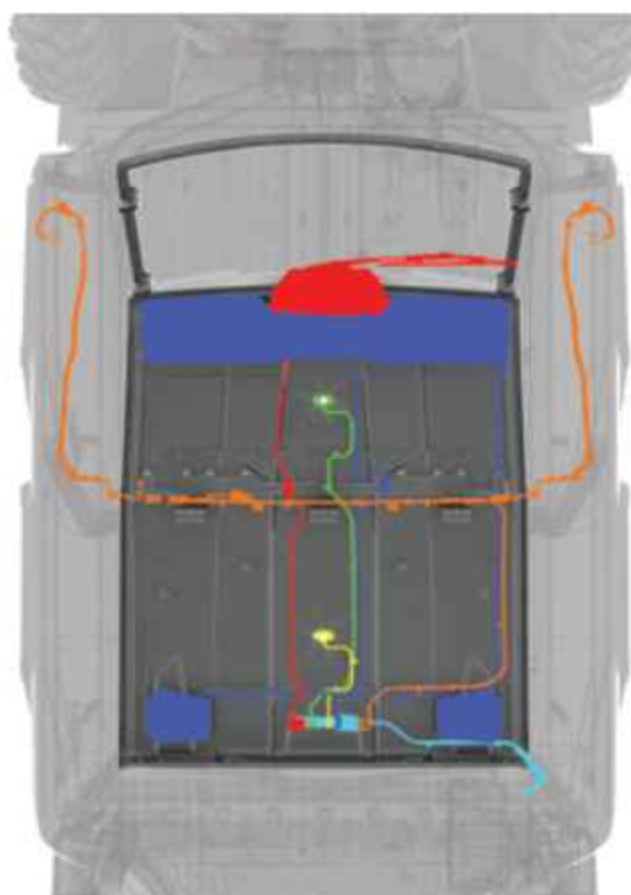

CREW XP 1000 POLARIS PULSE WIRING SHOWN

STEP 3 ADD ACCESSORIES*	1000 / XP 1000 / XP KINETIC	CREW 1000 / XP 1000	SP 570	CREW SP 570
POWER WINDOW DOORS				
Polaris PULSE Wiring Harness - Crew Extension	N/A	2883231 \$24 ^{MS}	N/A	

WINDSHIELD WIPER & WASHER SYSTEM	1000 / XP 1000 / XP KINETIC	CREW 1000 / XP 1000	SP 570	CREW SP 570
Windshield Wiper & Washer System	2883974 \$589 ^{MS}		2885083 \$514 ^{MS}	
Polaris PULSE Wiring Harness - Crew Extension	N/A	2883231 \$24 ^{MS}	2889185 \$84 ^{MS}	

AUDIO: VISOR AUDIO + REAR SPEAKERS	1000 / XP 1000 / XP KINETIC	CREW 1000 / XP 1000	SP 570	CREW SP 570
300 Watt AM/FM, Bluetooth® Audio Visor with Four 6.5" Waterproof Speakers	2882888 \$899 ^{MS}		N/A	
Rear Overhead Speakers	2882876 \$249 ^{MS}		N/A	
Polaris PULSE Wiring Harness - Crew Extension	N/A	2883231 \$24 ^{MS}	N/A	

AUDIO: DASH RADIO & VISOR SPEAKERS	1000 / XP 1000 / XP KINETIC	CREW 1000 / XP 1000	SP 570	CREW SP 570
150 Watt, Waterproof AM/FM Bluetooth® Audio System	2882750 \$679 ^{MS}		N/A	
300 Watt Overhead Audio Visor Speakers	2882891 \$699 ^{MS}		N/A	
IBL® Dash Audio Kit	N/A		2885081 \$699 ^{MS}	
Polaris PULSE Wiring Harness - Crew Extension	N/A	2883231 \$24 ^{MS}	2889185 \$84 ^{MS}	

WORK LIGHT	1000 / XP 1000 / XP KINETIC	CREW 1000 / XP 1000	SP 570	CREW SP 570
Rear LED Work Light		2889672 \$249 ^{MS}		
Polaris PULSE Wiring Harness - Crew Extension	N/A	2883231 \$24 ^{MS}	2889185 \$84 ^{MS}	

*Add accessories to models without "I" Display Powered by RIDE COMMAND

**To add a Multi-Function Dome Light for rear passengers, add an additional 2882911

***Check with your local dealer for availability.

STEP 4 FINISHING TOUCH	1000 / XP 1000 / XP KINETIC	CREW 1000 / XP 1000	SP 570	CREW SP 570
CONCEAL WIRING FOR A FINISHED, COMFORTABLE LOOK				
Premium Roof Liner	2882914 \$214 ^{MS}	2883457 \$349 ^{MS}	2885083 \$194 ^{MS}	2885084 \$514 ^{MS}



EASILY ADD LIGHTING

With Polaris PULSE it's easy to add RIGID® and Pro Armor lighting to your RANGER. All LED Light bars listed on P. 56-57 are Polaris PULSE ready, making installation that much easier.

POLARIS PULSE LIGHT BAR WIRING LOCATIONS

FRONT BUMPER // ROOF - FRONT MOUNTED // ROOF - REAR MOUNTED // *CREW ROOF - REAR MOUNTED

*Requires Extension

RANGER 1000 / XP 1000 / XP KINETIC	RANGER SP 570
1 LIGHT WITH 1 SWITCH	
TOP RIGID Polaris PULSE Wiring Harness - 1 LED Light Bar - 2883230 - \$94 ^{MS} + Upper Switch Panel Light Bar Harness** 2880675 - \$119 ^{MS}	Polaris PULSE Wiring Harness - 1 LED Light Bar - 2889161 - \$94 ^{MS}
2 LIGHTS WITH 1 SWITCH	
TOP RIGID Polaris PULSE Wiring Harness - 1 LED Light Bar - 2883230 - \$94 ^{MS} Y-Harness - 2879860 - \$19 ^{MS}	N/A
2 LIGHTS WITH 2 SWITCHES	
TOP RIGID Polaris PULSE Wiring Harness - 1 LED Light Bar - 2883230 - \$94 ^{MS} TOP RIGID Polaris PULSE Wiring Harness - 1 LED Light Bar - 2883230 - \$94 ^{MS}	Polaris PULSE Wiring Harness - 1 LED Light Bar - 2889161 - \$94 ^{MS} Polaris PULSE Wiring Harness - 1 LED Light Bar - 2889161 - \$94 ^{MS}
EXTENSIONS FOR CREW	
Polaris PULSE Wiring Harness - 1 LED Light Bar - Crew Extension 2883231 - \$24 ^{MS} + Upper Switch Panel Light Bar Harness - Extension** 2890067 - \$29 ^{MS}	N/A

POLARIS
NORTHSTAR
COOLER

KEEP IT
ICE COLD

GRIZZLY TESTED.
POLARIS APPROVED.



This cooler is IGBC-approved, meaning it withstands the power expended by a typical grizzly bear if it was trying to get inside. Seriously, there are experts who know what a grizzly is capable of doing, and they certify our coolers can take it.



30, 60 & 105
QUART FEATURES



ComfortCarry Handles



TravelLock System



EasyOut Drain System



NoSlip Rubber Feet



PolarWall Insulation



IceLock Seal

POLARIS NORTHSTAR COOLERS CAN SURVIVE JUST ABOUT ANYTHING - FROM EXTREME HEAT TO A NASTY TUMBLE OFF A VEHICLE.



105 QUART

► GRAPHITE • 2883426 • **\$419**^{MS}
► DESERT • 2883392 • **\$419**^{MS}



60 QUART

► GRAPHITE • 2883425 • **\$329**^{MS}
► DESERT • 2881259 • **\$329**^{MS}



30 QUART

► GRAPHITE • 2883424 • **\$259**^{MS}
► DESERT • 2881315 • **\$259**^{MS}



15 QUART

► GRAPHITE • 2883968 • **\$199**^{MS}



20 QUART SOFT-SIDED COOLER

► 2889285 • **\$189**^{MS}

HOLDS ICE
30+
HOURS
LONGER
THAN YETI™

*YE TI™ is a registered trademark of YETI COOLERS, LLC.

ESSENTIAL ACCESSORIES SO YOUR COOLER WORKS AS HARD AS YOU DO

COOLER ACCESSORIES		105 QUART	60 QUART	30 QUART	DON'T FORGET THESE ACCESSORIES		
	WIRE BASKET	2883648 • \$44 ^{MS}	2882185 • \$30 ^{MS}	2882438 • \$25 ^{MS}		TUMBLER	► 20 OZ • 2883393 • \$24 ^{MS}
	DIVIDERS Doubles as cutting board	2883468 • \$34 ^{MS} COMES WITH ONE DIVIDER 1 way to partition	2882184 • \$44 ^{MS} COMES WITH TWO DIVIDERS 2 ways to partition	2882186 • \$24 ^{MS} COMES WITH ONE DIVIDER 1 way to partition		LOCK & RIDE QUICKSTRAP	► 2882187 • \$44 ^{MS} ALL COOLERS AND POLARIS RANGER CARGO BOXES
	SEAT CUSHION	NOT AVAILABLE	2882179 • \$89 ^{MS}	2882507 • \$69 ^{MS}		BOTTLE OPENER	► 2882183 • \$14 ^{MS} ALL COOLERS
	WHEELS	2883967 • \$94 ^{MS}	2882180 • \$99 ^{MS}	NOT AVAILABLE			

COMMON ACCESSORIES

CONNECTED TECHNOLOGY

ELECTRICAL ACCESSORIES

COOLERS

HUNT

COLD WEATHER

PLOW

LIGHTS

WHEELS & TIRES

PROTECTING YOUR ESSENTIAL GEAR SINCE 1943

KOLPIN STRONGHOLD SYSTEM

Polaris is proud to partner with Kolpin Outdoors, an industry leader in off-road accessories and the premier name in gun boots and mounts. If you need to secure a firearm while riding, simply attach the auto-latch mount and choose your Gun Boot.

IDEAL FOR SECURE TRANSPORT OF SCOPED RIFLES AND SHOTGUNS

STEP 1 CHOOSE YOUR MOUNT



LOCK & RIDE KOLPIN STRONGHOLD AUTO-LATCH DOUBLE BOOT MOUNT

- Precision angle adjustable for a custom fit
- Provides a quick and secure attachment point

▶ **DOUBLE BOOT MOUNT - 2883970 - \$184^{MS}**
▶ **SINGLE BOOT MOUNT - 2884106 - \$69^{MS}**

RHINO-RACK[™]



RHINO-RACK[™] - GUN BOOT MOUNT

- Bracket used to mount Kolpin Stronghold Gun Boots to Rhino-Rack[™] systems when paired with Auto-Latch Mount (2884106), sold separately

▶ **2889327 - \$54^{MS}**

XP 1000 '18-23, CREW XP 1000 '19-23,
CREW 1000 '20-23, 1000 '20-23
REQUIRES AUTO-LATCH MOUNT 2884106 TO
MOUNT TO VEHICLE
SEE P. 36 FOR MORE RHINO-RACK[™] PRODUCTS

STEP 2 CHOOSE YOUR BOOTS



KOLPIN STRONGHOLD GUN BOOT XL

- Lockable and TSA approved
- Includes padded, zippered internal protective liner
- 52" L x 3 3/4" W x 10 1/2" H

▶ **2882036 - \$89^{MS}**

REQUIRES AUTO-LATCH MOUNT
2883970 OR 2884106 TO MOUNT
TO VEHICLE

KOLPIN STRONGHOLD GUN BOOT L

- 52" L x 4 3/4" W x 9 1/2" H

▶ **2882426 - \$59^{MS}**

REQUIRES AUTO-LATCH MOUNT
2883970 OR 2884106 TO MOUNT
TO VEHICLE

CARGO BED REAR WINCH

- Assists lifting heavy objects like hay bales or big game up into rear cargo bed
- 300 lb. winch mounts high on rear cab frame
- Equipped with 15 ft. of premium synthetic rope

▶ **2884215 - \$599^{MS}**

XP 1000 '18-23, CREW XP 1000 '19-23,
CREW 1000 '20-23, 1000 '20-23



KOLPIN RHINO GRIPS IDEAL FOR CARRYING RIFLES, SHOTGUNS, BOWS AND CROSSBOWS



LOCK & RIDE RHINO GRIP PRO

▶ **2884107 - \$89^{MS}**
ALL RANGER MODELS (EXCEPT 150 EFI)



LOCK & RIDE RATCHETING RHINO GRIP

▶ **2881575 - \$69^{MS}**
ALL RANGER MODELS (EXCEPT 150 EFI)



LOCK & RIDE RHINO GRIP XLR

▶ **2889165 - \$49^{MS}**
ALL RANGER MODELS (EXCEPT 150 EFI)



LOCK & RIDE RHINO GRIP XLR DOUBLES

▶ **2889166 - \$74^{MS}**
ALL RANGER MODELS (EXCEPT 150 EFI)



RHINO GRIP PRO REPLACEMENT RUBBER STRAPS (2)

▶ **2884109 - \$9^{MS}**
RHINO GRIP PRO



RHINO GRIP XLR REPLACEMENT RUBBER STRAPS (2)

▶ **2889204 - \$9^{MS}**
RHINO GRIP XLR

LOCK & RIDE GUN RACK 6

- Adjustable to store guns at an angle or vertical (shown at angle)
- Holds six rifles or shotguns securely with soft rubber v-grips
- Stock is secured in place with a soft molded rubber inlay along the bottom of the rack
- Rack can be adjusted into three positions based on firearm height

▶ **2882159 - \$434^{MS}**

XP 1000 '17-23, CREW XP 1000 '18-23, CREW 570
FULL SIZE '18-23, CREW 1000 '20-23, 570 FULL SIZE
'17-23, 1000 '20-23



IN-CAB GUN MOUNT

- Gives you instant gun access in the field
- Mounts securely to the floor and adjusts up to 45° forward
- Robust, molded gun butt holder at base
- Quick-release barrel straps
- Easily removable
- Accommodates scope-equipped rifles

▶ **2883263 - \$164^{MS}**

XP 1000 '18-23, CREW XP 1000 '19-23,
CREW 1000 '20-23, 1000 '20-23
NORTHSTAR EDITION REQUIRES 2208023
HWD KIT TO INSTALL ON THE 2019 AND
NEWER MODELS



POLARIS PURSUIT CAMO SxS FIELD COVER

- Full-coverage camo print cover hides your side-by-side while in the field
- Lightweight material protects your RANGER from inclement weather

▶ **2882160 - \$129^{MS}**

XP 1000 '18-23, EV '11-23, 570 FULL SIZE '17-23, 570
'14-21, 570 '22-23, 500 '19-23, 1000 '20-23

COLD WEATHER

GET READY FOR WINTER WITH PLOWS AND TRACKS. SEE P. 52 FOR PLOW DETAILS

POLARIS PLOW MODE

EXCLUSIVE TO RANGER XP 1000 RIDE COMMAND FOR 2020-2023

7" DISPLAY POWERED BY RIDE COMMAND*

2884072 • \$1,594^{MS}

XP 1000 '19-23, CREW XP 1000 '19-23, CREW 1000 '20-23, 1000 '20-23, XP KINETIC '23

SEE P. 42

Plow mode functionality does not control hydraulic lift and angle. *Due to ongoing supply chain issues, there may be delayed or limited availability of this product as an accessory add-on.



PLOW IS AUTOMATICALLY LOWERED WHEN SHIFTING INTO LOW



PLOW IS AUTOMATICALLY RAISED WHEN SHIFTING INTO REVERSE



BACK DRAG MODE ALLOWS FOR PULLING SNOW AWAY FROM BUILDINGS

Prospector PRO TRACK SYSTEM

PROSPECTOR PRO TRACK MOUNT KIT

• Install this track system mounting hardware in place of tires and wheels. Tracks sold separately.

2889425 • \$549^{MS}

XP 1000 '21-23, CREW XP 1000 '21, CREW 1000 '20-23, 1000 '21-23. FITS MODELS WITH NON-HIGH CLEARANCE A ARMS

2889426 • \$549^{MS}

XP 1000 '21-23, CREW XP 1000 '21-23. FITS MODELS WITH HIGH CLEARANCE A ARMS

2882783 • \$549^{MS}

XP 1000 '19-21, CREW XP 1000 '19-21, CREW 1000 '20-21, 1000 '20-21

2880071 • \$549^{MS}

CREW 570-4 '15-21, 570 '14-21, 500 '17-23

2889196 • \$549^{MS}

SP 570 '22-23. REQUIRES 2880758, SOLD SEPARATELY

PROSPECTOR PRO 2.0 TRACK

2890034 • \$5,499^{MS}

XP 1000 '18-23, CREW XP 1000 '18-23, CREW 1000 '20-23, 1000 '20-23

2889487 • \$5,499^{MS}

SP 570 '22-23, CREW SP 570 '22-23

PROSPECTOR PRO TRACK

2880758 • \$5,499^{MS}

570 '14-21 WITH EPS, CREW 570 '14-21 WITH EPS

2880757 • \$5,499^{MS}

CREW 570-4 '14-21, 570 '14-21, 500 '17-23

If using Glacier Pro Plow System with tracks, Track Plow Extension is required (2889067)

For your round use, Polaris recommends the use of Intake Update Kit (2880071) on any RANGER XP 1000 '17, RANGER XP 1000 CREW '19-23 with tracks installed. To keep intake system working optimally, this kit pre-filters out fine snow and dust.



1 INDUSTRY'S FIRST - FLEX-TRACK DESIGN

Front-mounted tracks with flexible sides and slight curve toward the inside to allow stable handling, a more comfortable ride, and precise steering for long-distance riding and long working hours.

2 HIGH-DENSITY TIRE WITH ADJUSTED SHAPE

With puncture-proof tires that reduce friction and wear, the Prospector Pro 2.0 Tracks delivers trouble-free performance.

Take on bumps and obstacles with confidence with the 8" high-density tracks.

3 LIGHTWEIGHT POWDER COAT STEEL FRAME

Proven geometry to improve durability and deliver capability in all conditions throughout the life of the tracks.

The lighter frame provides more flotation to stay on top of the snow and allows the tracks to easily shed snow, mud, and debris.

4 TANDEM STABILIZER

Bolt-on tandem mid-roller wheel provides a smoother ride by absorbing shocks.

5 BEARING HOUSING

Outer seals and stainless steel sleeves allow stronger bearing durability and greater reliability.

6 WHEEL CAP & SEAL

Fitted wheel cap with bladder effect eliminates water absorption due to temperature variation. Ride in snow and mud and not worry about the track maintenance.

Otter



FEATURES

- Fits 1-2 people
- 26.5 square ft.
- Set up dimensions: 67" L x 59 1/2" W x 78 1/2" H
- Cover included
- 2 top sealable vents
- Front entry door with dual coil zippers
- 2 sewn-in TPU crack resistant windows
- Insulated corners for complete coverage
- Interior draft skirt with extra-long perimeter



1 YR WARRANTY

POLARIS RANGER COMPATIBLE MODELS



XP 1000 '15-23, CREW XP 1000 '16-23, CREW 1000 '20-23, 1000 '20-23



CREW 570 FULL SIZE '16-23, 570 FULL SIZE '17-23



XP KINETIC '23

LOCK & RIDE

Polaris XT Pro Lodge by Otter

2882199 • \$1,029^{MS}

VEHICLE WITH TRACKS WILL REDUCE SITTING SPACE IN HOUSE SLIGHTLY



LOCK & RIDE Easy On & Off



Room for Ice Fishing Gear



Comfortable Fishing for 2

EASY SET UP



Otter TEC



OUTER SHELL
Provides outstanding wind and light blocking capabilities



INNER LINING
The full thermal quilted inner shell provides higher lofting while locking in heat and virtually eliminating condensation



LIGHTWEIGHT
Oversized square tube aluminum frame with anodized receiver tubes and ultra-glide operation



"The full-thermal Otter® Ice House from Polaris sets up in minutes, is spacious enough for two anglers to fish in comfort and stows quickly on the back of your RANGER. It is the premium shelter solution for ice anglers that rely on their Polaris RANGER for mobility out on the ice."

- James Holst, InDepth Outdoors

Otter® is a registered trademark of Otter Outdoors, LLC

REAR 27" TIRE CHAINS

- Improve traction in deep snow and icy terrain
- Designed to fit on the 11" wide rear tires of the RANGER XP 1000

2889242 • \$149^{MS}

NEW 29" TIRE CHAINS*

- Improve traction in deep snow and icy terrain
- Wide enough to fit on the broader rear tires of the RANGER XP 1000

2889816 • \$104^{MS}

*Check with your local dealer for availability.

GLACIER PRO HD PLOW SYSTEM

HYDRAULIC CONTROL FOR EXTREME SNOW REMOVAL

A robust frame and tough blades, combined with a convenient hydraulic angle system, allow your Glacier Pro HD to move serious snow while you remain comfortable. Thanks to Lock & Ride technology, the Pro HD comes standard with a convenient kickstand attachment to the plow frame, giving you the easiest attachment.

1000 / XP 1000 / XP KINETIC PLOW SYSTEMS (REQUIRES WINCH, SOLD SEPARATELY)

Choose a Glacier Pro HD Plow System, designed to help you get the most out of your RANGER during snowy months. Select a system based on your plowing needs with premium add-ons including a hydraulic lift system or additional plow accessories.

GLACIER PRO HD PLOW SYSTEM WITH HYDRAULICS & ACCESSORIES

- System Includes:
- Frame (2889308)
 - 72" Poly Blade (2879317)
 - Hydraulic Angle (2889029)
 - Hydraulic Controller (2883247)
 - Plow Markers (2872726)
 - Back Drag Bar (2889328)
 - Plow Extensions (2889328)

▶ **3880002 • \$3,804****
 XP 1000 '18-23, CREW XP 1000 '19-23, CREW 1000 '20-23, 1000 '20-23, XP KINETIC '23
 REQUIRES LIFT METHOD: SEE WINCHES

GLACIER PRO HD PLOW SYSTEM WITH HYDRAULICS

- System Includes:
- Frame (2889308)
 - 72" Poly Blade (2879317)
 - Hydraulic Angle (2889029)
 - Hydraulic Controller (2883247)
 - Plow Markers (2872726)

▶ **3880003 • \$2,649****
 XP 1000 '18-23, CREW XP 1000 '19-23, CREW 1000 '20-23, 1000 '20-23, XP KINETIC '23
 REQUIRES LIFT METHOD: SEE WINCHES

GLACIER PRO HD PLOW SYSTEM

- System Includes:
- Frame (2889308)
 - 72" Steel Blade (2879874)
- ▶ **3880004 • \$1,714****
 XP 1000 '18-23, CREW XP 1000 '19-23, CREW 1000 '20-23, 1000 '20-23, XP KINETIC '23
 REQUIRES LIFT METHOD: SEE WINCHES

BUILD YOUR 1000 / XP 1000 / XP KINETIC PLOW SYSTEM

- ▶ **72" Blades**
- ▶ **Choice of poly or steel**
- ▶ **Hydraulic lift & angle system option**



BUILD YOUR PLOW SYSTEM	STEP 1 SELECT A MOUNT	STEP 2 SELECT A FRAME	STEP 3 SELECT PLOW CONTROL		STEP 4 SELECT A BLADE
MODELS	MOUNT	FRAME	HYDRAULICS	WINCHES	BLADES
XP 1000 '18-23 CREW XP 1000 '19-23 1000 '20-23 CREW 1000 '20-23 XP KINETIC '23	Not Required Integrated into Factory Bumper NON EPS RANGER 1000 REQUIRES FRONT BUMPER	Frame 2889308 \$1,299** Track Extension 2879871 \$484** Replacement T Shear Pin 2204829 \$9** Glacier Pro HD Kickstand System 2207382 \$24**	Hydraulic Lift System 2889058 \$484** Glacier Pro HD Plow Hydraulic Angle System 2889029 \$569** TOP SELLER Power Controller 2883247 \$214** REQUIRED FOR HYDRAULIC COMPONENTS	Polaris Pro HD 6,000 lb. Winch 2882710 \$979** TOP SELLER Polaris Pro HD 4,500 lb. Winch 2882711 \$899** Power Controller Winch Adapter 2884159 \$54**	72" Poly 2879317 \$699** TOP SELLER 72" Steel 2879874 \$549**

SELECT ACCESSORIES

- PLOW BLADE SNOW DEFLECTOR**
- ▶ 72" • 2858541 • \$69**
 - ▶ 66" • 2879866 • \$89**
 - ▶ 60" • 2871808 • \$69**

- HEAVY-DUTY SNOW PLOW DEFLECTOR**
- ▶ 72" • 2884160 • \$154**

- QUICK RELEASE SKID SHOES**
- Helps prevent blade wear
 - Hardened steel for industrial strength
 - ▶ 2205223 • \$34**

- COIL SPRING SPACER**
- Keep the front end of the vehicle up and improve ride quality when using a plow on strut or A-Arm vehicles
 - ▶ 2872655 • \$24**

- GLACIER 6" PLOW EXTENSIONS**
- 6" steel plow extensions that attach to the side of 66" and 72" Glacier Pro HD plows
 - ▶ 2889328 • \$249**

POLARIS SP 570 PLOW SYSTEMS (REQUIRES WINCH, SOLD SEPARATELY)



GLACIER PRO HD PLOW SYSTEM WITH HYDRAULICS

- System Includes:
- Quick Release Hook (2889577)
 - Frame (2880260)
 - 72" Steel Blade (2880270)
 - Hydraulic Angle (2889032)
 - Hydraulic Controller (2889162)
 - Plow Markers (2872726)

▶ **3880005 • \$2,189****
 SP 570 '22-23 & CREW SP 570 '22-23
 REQUIRES LIFT METHOD: SEE WINCHES

GLACIER PRO HD PLOW SYSTEM (NON BASE MODELS)

- System Includes:
- Quick Release Hook (2889577)
 - Frame (2880260)
 - 66" Poly Blade (2880269)

▶ **3880007 • \$1,884****
 SP 570 '22-23 & CREW SP 570 '22-23
 REQUIRES LIFT METHOD: SEE WINCHES AND HYDRAULIC LIFT OPTION

GLACIER PRO HD PLOW SYSTEM (BASE MODELS ONLY)

- System Includes:
- Mount (2889195)
 - Quick Release Hook (2889577)
 - Frame (2880260)
 - 66" Poly Blade (2880269)

▶ **3880008 • \$1,194****
 SP 570 '22-23 & CREW SP 570 '22-23
 REQUIRES LIFT METHOD: SEE WINCHES AND HYDRAULIC LIFT OPTION

BUILD YOUR SP 570/570/500/570 FULL-SIZE PLOW SYSTEM

- ▶ **72" or 66" Blades**
- ▶ **Choice of poly or steel**
- ▶ **Hydraulic angle system option**



BUILD YOUR PLOW SYSTEM	STEP 1 SELECT A MOUNT	STEP 2 SELECT A FRAME	STEP 3 SELECT PLOW CONTROL		STEP 4 SELECT A BLADE
MODELS	MOUNT	FRAME	HYDRAULICS	WINCH	BLADES
570 FULL-SIZE '16-23 CREW 570 FULL-SIZE '16-23 500 '10-23 570/CREW 570 '10-21 LI-ION EV & EV '15-23	Mount & Quick Release Hook 2880261 \$269**	TOP SELLER Frame 2880260 \$484** Frame Extension 2880267 \$269** FOR VEHICLES USING TRACK SYSTEM Replacement Shear Pin 2205527 \$9**	Glacier Pro HD Plow Hydraulic Angle System 2889032 \$639** Power Controller 2879227 \$49** NO SHIFTER TO MOUNT CONTROLLER ON EV REQUIRED FOR HYDRAULIC COMPONENTS	Polaris Pro HD 4,500 lb. Winch 2882238 \$874**	TOP SELLER 72" Steel 2880270 \$549** TOP SELLER 66" Poly 2880269 \$459** TOP SELLER 66" Steel 2880268 \$409**
SP 570/CREW SP 570 '22-23 PREMIUM AND NORTHSTAR EDITION MODELS	Quick Release Hook 2889577 \$159** REQUIRED FOR ALL TRIMS MOUNT INTEGRATED INTO FRONT BUMPER	Mount 2889195 \$159** Quick Release Hook 2889577 \$159**	Glacier Pro HD Plow Hydraulic Angle System 2889032 \$639** NEW Power Controller 2889162 \$359** NO SHIFTER TO MOUNT CONTROLLER ON EV REQUIRED FOR HYDRAULIC COMPONENTS	Polaris Pro HD 4,500 lb. Winch 2885096 \$849**	

- WEAR BARS**
- Protect your plow blade and minimize wear on the actual blade
 - ▶ 72" • 2204976 • \$59**
 - ▶ 66" • 2879867 • \$59**
 - ▶ 60" • 2877243 • \$39**
 - ▶ HD 72" • 2879875 • \$114**
 - ▶ HD 66" • 2879868 • \$109**

- PLOW BACK DRAG BAR**
- Has a hinged, rear facing cutting edge that improves back dragging performance and allows the bar to float when plowing forward to reduce wear and tear
 - ▶ 2889328 • \$104**

- QUICK RELEASE SKID SHOES**
- Helps prevent blade wear
 - Hardened steel for industrial strength
 - ▶ 2208864 • \$29**

- PLOW MARKER**
- Helps driver monitor plow blade position
 - Sold in pairs
 - ▶ 2872726 • \$39**

- PLOW LINK**
- ▶ 2204974 • \$19**

BUILD A PLOW SYSTEM

CHOOSE A PLOW SYSTEM

COMMON ACCESSORIES

CONNECTED TECHNOLOGY

ELECTRICAL ACCESSORIES

COOLERS

HUNT

COLD WEATHER

PLOWING

LIGHTS

WHEELS & TIRES

GLACIER HD PLOW SYSTEM

MAKE QUICK WORK OF THE SMALLER JOBS

Move some snow with the sturdy and capable Glacier HD plow system, and discover why a major snowfall can be the highlight of your week. With a robust frame, beefy poly and steel blade options, convenient Lock & Ride mounting and dismounting and amazing value, Glacier HD is a great choice in the dead of winter.



3-SEAT & CREW >72" or 66" Blades >Choice of poly or steel >Manual angle system standard



2-SEAT & CREW 570 FULL-SIZE & CREW >66" Blades >Choice of poly or steel



BLADE MATERIAL
Durable poly and steel blades are designed to push more. Choose a steel blade for longevity and increased rigidity or a lightweight non-stick, poly blade that's easier on plowing surfaces.

BUILD A PLOW SYSTEM				
MODELS	STEP 1 SELECT A MOUNT	STEP 2 SELECT A FRAME	STEP 3 SELECT A LIFT METHOD	STEP 4 SELECT A BLADE
XP 1000 '18-23 CREW XP 1000 '19-23 1000 '20-23 CREW 1000 '20-23 XP KINETIC '23 <small>NOT COMPATIBLE WITH 29" OR LARGER TIRES</small>	Not Required Integrated into Factory Brushguard <small>NON EPS RANGER 1000 REQUIRES FRONT BUMPER</small>	Frame 2889307 \$549 ^{MS} Replacement Shear Pin 2205527 \$9 ^{MS}	<small>TOP SELLER</small> 72" Steel 2880270 \$549 ^{MS} <small>TOP SELLER</small> Polaris HD 4,500 lb. Winch 2882714 \$679 ^{MS} <small>TOP SELLER</small> 66" Steel 2880268 \$409 ^{MS}	

BUY A PLOW SYSTEM
GLACIER HD PLOW SYSTEM System Includes: - Frame (2889307) - 72" Steel blade (2880270) \$3880005 • \$874 ^{MS} <small>XP 1000 '18-23, CREW XP 1000 '19-23, CREW 1000 '20-23, 1000 '20-23, XP KINETIC '23</small> <small>REQUIRES LIFT METHOD: SEE WINCHES</small>

BUILD A PLOW SYSTEM				
MODELS	STEP 1 SELECT A MOUNT	STEP 2 SELECT A FRAME	STEP 3 SELECT A LIFT METHOD	STEP 4 SELECT A BLADE
570 FULL-SIZE '16-23 CREW 570 FULL-SIZE '16-23 500/ETX '10-23 570/CREW 570 '10-21 LI-ION EV & EV '15-23	Mount 2879105 \$164 ^{MS}	Frame 2889307 \$549 ^{MS} Replacement Shear Pin 2205527 \$9 ^{MS}	<small>TOP SELLER</small> Polaris HD 3,500 lb. Winch 2881669 \$494 ^{MS} Polaris Pro HD 4,500 lb. Winch 2885096 \$449 ^{MS}	<small>TOP SELLER</small> 66" Poly 2880269 \$459 ^{MS} <small>TOP SELLER</small> 66" Steel 2880268 \$409 ^{MS}
SP 570/CREW SP 570 '22-23	Mount 2889195 \$159 ^{MS} <small>NOT REQUIRED ON PREMIUM AND NORTHSTAR EDITION MODELS</small>			

BUY A PLOW SYSTEM
GLACIER HD PLOW SYSTEM System Includes: - Frame (2889307) - 66" Steel blade (2880268) \$3880009 • \$874 ^{MS} <small>SP 570 '22-23 & CREW SP 570 '22-23</small> <small>REQUIRES LIFT METHOD: SEE WINCHES</small>

SELECT ACCESSORIES

- WEAR BARS**
 - Protect your plow blade and minimize wear on the actual blade
 - > 72" • 2204976 • \$59^{MS}
 - > 66" • 2879867 • \$59^{MS}
 - > 60" • 2877243 • \$39^{MS}
 - > HD 72" • 2879875 • \$114^{MS}
 - > HD 66" • 2879868 • \$109^{MS}
- PLOW BLADE SNOW DEFLECTOR**
 - > 72" • 2858541 • \$69^{MS}
 - > 66" • 2879866 • \$89^{MS}
 - > 60" • 2871808 • \$69^{MS}
- HEAVY-DUTY SNOW PLOW DEFLECTOR**
 - > 72" • 2884160 • \$154^{MS}
- QUICK RELEASE SKID SHOES**
 - Helps prevent blade wear
 - Hardened steel for industrial strength
 - > 2208864 • \$29^{MS}
- COIL SPRING SPACER**
 - Keep the front end of the vehicle up and improve ride quality when using a plow on strut or A-Arm vehicles
 - > 2872655 • \$24^{MS}
- QUICK RELEASE SKID SHOES**
 - Helps prevent blade wear
 - Hardened steel for industrial strength
 - > 2208864 • \$29^{MS}
- PLOW MARKER**
 - Helps driver monitor plow blade position
 - Sold in pairs
 - > 2872726 • \$39^{MS}
- GLACIER PLOW LINK**
 - > 2204974 • \$19^{MS}

COMMON ACCESSORIES

CONNECTED TECHNOLOGY

ELECTRICAL ACCESSORIES

COOLERS

HUNT

COLD WEATHER

PLOWING

LIGHTS

WHEELS & TIRES

RIGID

POLARIS ENGINEERED ADVANTAGES

MOUNTS PERFECTLY
Designed for your Polaris Engineered bumper, roof or other mounting point.

MAX PERFORMANCE
Validated to work as hard as your machine does.

DOESN'T OVERTAX
Trust it to work when you need it to.

PRO ARMOR

ADVANCED TECH

RIGID® lights are driven by Aluminum PCB Smart Boards™, 6063-T5 aircraft aluminum extruded housings and Tiger Drylac® UV protection polyester powder-coating.

EXCLUSIVE OPTICS

RIGID® lights feature impact-resistant polycarbonate lenses for a 100% water/dust proof seal.

RIGID® LIMITED LIFETIME WARRANTY

If you own a RIGID® light and it breaks, we will replace or repair it for life.*

RUGGED CONSTRUCTION

Pro Armor lights are designed to be big and beefy with an aggressive style all their own, and housed in IP67 marine-grade rated UV polyester powder coating.

MASSIVELY BRIGHT

Pro Armor builds bright lights designed for any riding experience. All that power is directed through heat dissipating aluminum for streamlined heat management.

LIGHT BAR TYPES



SR-SERIES PRO

Sleek, powerful, low-profile (under 2" tall). Lights extreme distances with low energy usage.

Available in 10" & 32"



D-SERIES PRO

Compact to fit almost anywhere with high output and low energy usage.

Available in Driving, Flood & Spot



DUAL-ROW LED

The most spread and farthest illumination downrange. Easy to mount.

Available in 11" & 31"



SINGLE-ROW LED

Powerful, compact, low-profile light bars with sleek look.

Available in 11", 20", 33" & 40"



CUBE LED

Small size allows mounting in strategic locations for added lighting.

Available in Spot

LIGHT BAR OPTIONS

FOR COMPATIBILITY VISIT POLARIS.COM/ShopRANGER

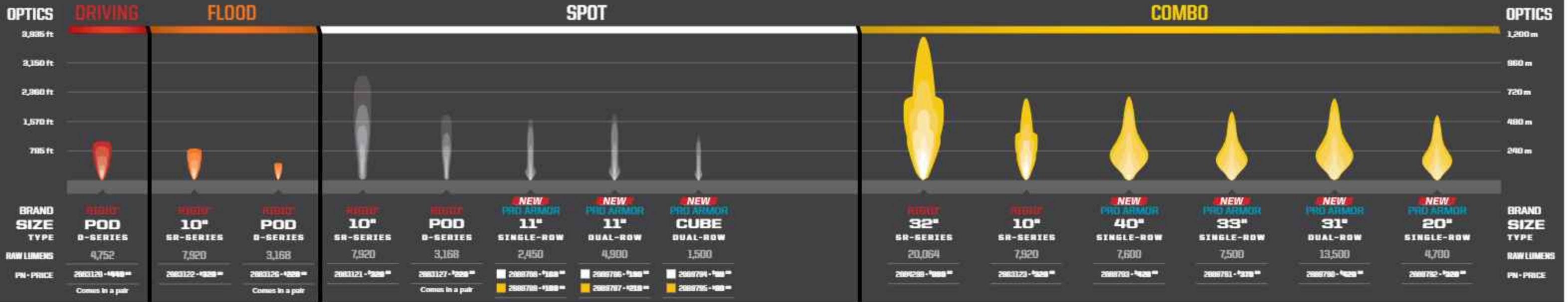

BUILD YOUR VISION

Consider the optics, angle & how you will use your vehicle to choose the right light or set of lights.

OPTICS LIGHT ANGLE	ACCENT	DRIVING (45°)	FLOOD (25°)	SPOT (10°)	COMBO (25°/10°)
DRIVING SPEED	All	Slow	Medium	Fast	Medium to fast
BEAM	Diffused glow	Extra-wide	Wide/Shorter	Concentrated/Long	Inner spot & outer flood
RECOMMENDED MOUNTING	Low/Wheel well	All points	Low &/or rear	High points	All points
TERRAIN & RIDING STYLE	Added style & personalization in any terrain	All riding & utility	Wide-open terrain or trails & utility	Trail & tight conditions	All riding & utility

COMPARE LIGHTS IN A REAL WORLD SETTING AT POLARIS.COM/LIGHTING

*RIGID® determines, in its sole discretion, that your product is defective in material or workmanship. RIGID® will honor your warranty claim. In some cases the product will be replaced, depending on the specific time frame of the purchase. If the product is repaired, all parts, labor, and return shipping may be covered by RIGID®.



ADD A HARNESS TO MOUNT YOUR LIGHTS

MODEL	LIGHT BAR SET-UPS		
	1 LIGHT IN 1 LOCATION ON 1 SWITCH	2 LIGHTS IN 2 LOCATIONS ON 1 SWITCH	2 LIGHTS IN 2 LOCATIONS ON 2 SWITCHES
EV 15-23, CREW 570-4 15-21, CREW 570 FULL SIZE 19-23, 570 FULL SIZE 17-23, 570 15-21, 500 17-23	Requires Battery Connection Cable LIGHT BAR HARNESS 2882209 - *\$89** UPPER SWITCH PANEL LIGHT BAR HARNESS* 2889675 - *\$119**	Requires Battery Connection Cable LIGHT BAR HARNESS 2882209 - *\$89** Y-HARNESS 2879860 - *\$19**	Requires Battery Connection Cable LIGHT BAR HARNESS (X2) 2882209 - *\$89**
SP 570 22-23 NON-PREMIUM AND NON-NORTHSTAR MODELS REQUIRE BATTERY CONNECTION CABLE			
XP 1000 19-21, CREW XP 1000 19-21, 1000 20-21, CREW 1000 20-21, XP KINETIC 23			

SEE P. 44 FOR WIRING CONNECTIONS

1 LED LIGHT BAR WIRING HARNESS - REAR FACING CREW EXTENSION

For installing rear facing light on Crew models
 • 2883854 - *\$24**
 XP 1000 20-23, CREW XP 1000 19-23, CREW 1000 20-23
 TO BE USED WITH LIGHT BAR HARNESS (2889675)

BATTERY CONNECTION CABLES 3-SEAT & CREW

• 3-SEAT - 2879388 - *\$39** • CREW - 2879685 - *\$59**
 XP 1000 17 CREW XP 1000 17-18

2-SEAT & CREW

• 570 - 2881684 - *\$34**
 2-SEAT - 2879990 - *\$49** EV 15-23, 570 15-21, 500 17-23
 EV 15-23, 570 15-21, 500 17-23 • SP 570 - 2889185 - *\$84**
 • CREW - 2880929 - *\$59** SP 570 SPORT 22-23,
 CREW 570-4 15-21 CREW SP 570 SPORT 22-23

ADD ADDITIONAL EXTERNAL LIGHTING

P. 27



*Check with your local dealer for availability.

COMMON ACCESSORIES

CONNECTED TECHNOLOGY

ELECTRICAL ACCESSORIES

COOLERS

HUNT

COLD WEATHER

PLANS

LIGHTING

WHEELS & TIRES

57

KNOW YOUR TERRAIN



- Tread patterns optimized for extreme traction
- Ideal for both hard pack and loose trail



- Flexible "grippy" tread
- Aggressive side bite



- Provides traction and durability
- Built to perform in hard sand, jagged rocks or any other extreme terrain



- Extra deep treads
- Self-cleaning lugs



- Paddles provide traction and durability in soft sand
- Built to float on top of sand



- Triple belted sidewalls to resist puncture
- Purpose-built, long lasting tread patterns



- Handles extreme cold
- Holds shape and provides traction

SUPERIOR PERFORMANCE & DURABILITY

WAYS TO SHOP WHEELS & TIRES

PRO ARMOR



LIFELONG PERFORMANCE

- Every tire is designed and constructed with longevity in mind
- 3,000+ mile rated (4,828 kilometers)

PREMIUM PROTECTION

- Pro Armor makes tires with extra protection exactly where it's needed most — the sidewall
- Triple-belted sidewalls keep your tires more resistant so you can keep going

TOUGH TIRES

- Higher ply ratings mean added protection
- Pro Armor builds 8 or 10-ply rated tires for higher puncture-resistance



KNOW YOUR TIRES

DIMENSIONS			TREAD DEPTH	TIRE WEIGHT	PLY RATING	SIDEWALL BELTS	LOAD RATING
TIRE HEIGHT	TIRE WIDTH	WHEEL DIAMETER					
32" x 9"	R15	FRONT/REAR	30 mm	41 lbs	10	3	1,320 lbs
Part Number • Price			TREAD DEPTH Deeper treads have more grip in all conditions		PLY RATING Indicates tire puncture-resistance		LOAD RATING How much weight can the tire handle
USAGE Where can you use the tire			TIRE WEIGHT A lighter tire makes for improved vehicle performance		SIDEWALL BELTS Increase your resistance to sidewall punctures		

TIRES BY SIZE

26"	27"	28"	29"
ATTACK	HARVESTER	ATTACK 2.0	DUAL-THREAT
DUAL-THREAT	MUD XC	CRAWLER XG	HD-K
HARVESTER	PRESERVE	CRAWLER XR	MUD XC
PRESERVE	X TERRAIN	HARVESTER	X TERRAIN
XD-K			

TIRES BY TERRAIN

TRAIL	ROCK	DESERT	MUD	UTILITY	SNOW
ATTACK	CRAWLER XG	ATTACK	MUD XC	HARVESTER	ATTACK
ATTACK 2.0	CRAWLER XR	ATTACK 2.0		HD-K	ATTACK 2.0
CRAWLER XG	DUAL-THREAT	CRAWLER XG		PRESERVE	HARVESTER
CRAWLER XR		CRAWLER XR		XD-K	HD-K
DUAL-THREAT		DUAL-THREAT		X TERRAIN	XD-K
HARVESTER					
HD-K					
MUD XC					
PRESERVE					
XD-K					
X TERRAIN					

WHEELS BY SIZE

14"	15"
40-SERIES (18 TIRE OPTIONS)	50-SERIES (2 TIRE OPTIONS)
4201	5201
4202	5202
4203 BEADLOCK	5203 BEADLOCK
4204	5204
4205	5301 BEADLOCK
4301 BEADLOCK	
HD DUAL BEADLOCK	

KNOW YOUR WHEELS

STEP 1: SELECT YOUR SERIES

4 - 40-SERIES 5 - 50-SERIES

STEP 2: CHOOSE YOUR LOAD RATING

1 - <800 lbs 2 - 801 - 1,300 lbs 3 - 1,301 - 1,600+ lbs

STEP 3: PICK YOUR STYLE

OFFSET / BEADLOCK / COLOR

INCREASE OFFSET FROM STOCK - NARROWER STANCE
DECREASE OFFSET FROM STOCK - WIDER STANCE

TIRES



X TERRAIN

- Built to perform through the toughest obstacles on any trail
- Durability-driven design to provide a comfortable, confident ride
- 8-ply, triple-belted ballistic sidewalls resist punctures

	TREAD DEPTH	TIRE WEIGHT	PLY RATING	SIDEWALL BELTS	LOAD RATING
27" x 9" R14 5410330-1159	16 mm	26 lbs	8	3	805 lbs
27" x 11" R14 5410331-1159		31 lbs			965 lbs
29" x 9" R14 5410332-1179		30 lbs			1,100 lbs
29" x 11" R14 5410333-1189		35 lbs			1,320 lbs



PRO ARMOR HARVESTER

- All-around work horse with tread life of 5,000 miles / 8,047 km
- Tread pattern designed to withstand anything from the farmyard to the pastures and the trail
- With 10-ply, it can carry the load day in and day out.

	TREAD DEPTH	TIRE WEIGHT	PLY RATING	SIDEWALL BELTS	LOAD RATING
26" x 8" R12 5415286-1189	16 mm	24 lbs	10	3	855 lbs
26" x 10" R12 5415288-1199		32 lbs			855 lbs
27" x 10" R14 5415285-1189		32 lbs			1,320 lbs
28" x 10" R14 5415247-1219		34 lbs			1,320 lbs



PICKING THE RIGHT UTILITY TIRE

UTILITY FEATURE	PRESERVE	HARVESTER	XD-K	HD-K	X TERRAIN
5,000 Mile / 8,047 Kilometer Rated Long life and performance	X	X			X
10-Ply Rated Higher ply ratings means added protection	X	X	X	X	
Low Impact Tread Easy on soil	X				
Heavy-Duty Tread Aggressive tread pattern for all day work on farms or ranches		X	X	X	X
Turf-Friendly Easy on grass and farm yard	X	X			X
Aramid Fiber Belt 5x times stronger than steel and lighter			X	X	
Size Options For exactly how you want to use your machine	26", 27"	26", 27", 28"	26"	29"	27", 29"



PRO ARMOR XD-K

- 26" Aramid fiber-belted tire to tackle any terrain
- Unique full-face tread design
- Harder durometer lugs promotes extended wear, increasing tire life

	TREAD DEPTH	TIRE WEIGHT	PLY RATING	SIDEWALL BELTS	LOAD RATING
26" x 9" R12 5415256-1227	31.7 mm	28 lbs	10	3/1 Aramid Fiber Belt	855 lbs
26" x 11" R12 5415257-1269		32 lbs			1,100 lbs



PRO ARMOR PRESERVE

- Turf-friendly for areas where low-impact from tire tread is needed
- Rounded profile and special tread pattern to limit footprint

	TREAD DEPTH	TIRE WEIGHT	PLY RATING	SIDEWALL BELTS	LOAD RATING
26" x 8" R12 5410101-1189	16 mm	24 lbs	10	3	855 lbs
26" x 10" R12 5410102-1199		28 lbs			1,320 lbs
27" x 10" R14 5410103-1199		28 lbs			1,390 lbs



PRO ARMOR HD-K

- Designed to provide a smooth ride and aggressive traction in all riding terrains
- Triple-belted sidewall provides extreme protection and extends the tire life
- Quad belt tread core offers superior protection and longer tread life

	TREAD DEPTH	TIRE WEIGHT	PLY RATING	SIDEWALL BELTS	LOAD RATING
29" x 10" R14 5412502-1316	31.75 mm	40 lbs	10	3/1 Aramid	1,320 lbs



TIRES



PRO ARMOR CRAWLER XR

- Premium grip for all terrains, from the trail to the rocks
- Square block profile for even surface contact
- A tougher durometer than the XG to take on the toughest the trail has to offer

	TREAD DEPTH	TIRE WEIGHT	PLY RATING	SIDEWALL BELTS	LOAD RATING	
28" • 10" R14 5911232 • 1218	FRONT/REAR	16 mm	32 lbs	8	3	1,140 lbs



XR

SINGLE DUROMETER

- Smaller lug height, added rigidity and lateral stability when cornering
- Unique lug design excels in hard pack, fast terrain



PRO ARMOR CRAWLER XG

- Built to crawl over all obstacles, both large and small
- A soft, sticky compound makes this tire ideal for both rock crawling and desert running
- 8-ply, triple-belted ballistic sidewalls resist punctures

	TREAD DEPTH	TIRE WEIGHT	PLY RATING	SIDEWALL BELTS	LOAD RATING	
28" • 10" R15 5911296 • 1219	FRONT/REAR	20 mm	32 lbs	8	3	1,110 lbs



WHAT CRAWLER ARE YOU?

XG

DUAL-DUROMETER

- Taller lug height and dual-durometer construction
- Perfect balance between high-speed performance, durability and flex in order to grip slick rock



PRO ARMOR MUD XC

- Designed as the perfect mud-trail crossover for a smooth ride on the trail and aggressive traction in the mud
- Dual-compound technology with harder durometer lugs promote extended wear, increasing tire life
- 10-ply construction means added protection in the toughest terrain

	TREAD DEPTH	TIRE WEIGHT	PLY RATING	SIDEWALL BELTS	LOAD RATING	
27" • 9" R14 5911297 • 1199	FRONT		30 lbs		1,170 lbs	
27" • 11" R14 5911298 • 1209	REAR	30 mm	32 lbs	10	3	1,320 lbs
29" • 10" R14 5911299 • 1219	FRONT/REAR		39 lbs		3	1,390 lbs



PRO ARMOR DUAL-THREAT

- Dual-compound technology and radial construction offer performance in all terrains
- Softer durometer rubber on outer edge for overall superior grip and feel
- Harder durometer rubber in the middle for increased traction during acceleration and longer tread life

	TREAD DEPTH	TIRE WEIGHT	PLY RATING	SIDEWALL BELTS	LOAD RATING	
26" • 9" R14 5911290 • 1179	FRONT		27 lbs		910 lbs	
26" • 11" R14 5911291 • 1189	REAR	16 mm	30 lbs	10	3	1,110 lbs
29" • 9" R14 5911292 • 1219	FRONT		30 lbs		1,110 lbs	
29" • 11" R14 5911293 • 1229	REAR		35 lbs		3	1,320 lbs



DUAL-COMPOUND - MORE GRIP + LONGER LIFE

Firmer Durometer Rubber - Longer Life



Softer Durometer Rubber - More Grip



PRO ARMOR ATTACK 2.0

- Engineered for excellent hard pack performance
- Dual-compound technology and radial construction offer performance in all terrains
- Tight tread pattern for quieter ride

	TREAD DEPTH	TIRE WEIGHT	PLY RATING	SIDEWALL BELTS	LOAD RATING	
28" • 10" R15 5911294 • 1219	FRONT/REAR	25 mm	32 lbs	10	3	1,110 lbs



TIGHTER TREAD PATTERN -
Better traction in hard pack

DUAL-DUROMETER LUG -
Increased grip & traction in rough terrain, smoother ride in all terrain

10-PLY RATED -
Increased durability

LARGER SIZE OFFERING IN 28" -
More ground clearance & trail traction



PRO ARMOR ATTACK

- The best all-purpose tire for all-season traction in any terrain
- Unique, full-face tread design
- Harder durometer lugs promote extended wear, increasing tire life
- Wider spaced lugs provide more grip in softer terrain

	TREAD DEPTH	TIRE WEIGHT	PLY RATING	SIDEWALL BELTS	LOAD RATING	
26" • 9" R14 5911263 • 1159	FRONT		29 lbs		910 lbs	
26" • 11" R14 5911264 • 1169	REAR	23 mm	32 lbs	8	3	1,320 lbs



KNOW YOUR TERRAIN



Tread patterns optimized for extreme traction
Ideal for both hard pack and loose trail



Flexible "grippy" tread
Aggressive side bite



Provides traction and durability
Built to perform in hard sand, jagged rocks or any other extreme terrain



Extra deep treads
Self-cleaning lugs



Paddles provide traction and durability in soft sand
Built to float on top of sand



Triple-beaked sidewalls to resist punctures
Purpose-built, long lasting tread patterns



Handles extreme cold
Holds shape and provides traction

WHEEL & TIRE SETS

14"

40-SERIES

UTILITY

HARVESTER 27" 5,000 MI/8,047 km

HARVESTER 26" 5,000 MI/8,047 km

PRESERVE 27" 5,000 MI/8,047 km

DESERT/ROCK

CRAWLER XR 28" 3,000 MI/4,826 km

MUD XC 27" 3,000 MI/4,826 km

MUD XC 29" 3,000 MI/4,826 km

4201 Accent	2882388 \$1,404 ^{MS}	2883225 \$1,524 ^{MS}	2883208 \$1,404 ^{MS}	2882394 \$1,404 ^{MS}	2884272 \$1,419 ^{MS}	2884265 \$1,499 ^{MS}
4201 Matte Black	2882389 \$1,299 ^{MS}	2883226 \$1,404 ^{MS}	2883209 \$1,299 ^{MS}	2882395 \$1,299 ^{MS}	2884273 \$1,309 ^{MS}	2884266 \$1,394 ^{MS}
4202 Accent	2882383 \$1,404 ^{MS}	2883220 \$1,524 ^{MS}	2883203 \$1,404 ^{MS}	2881343 \$1,404 ^{MS}	2884267 \$1,419 ^{MS}	2884260 \$1,499 ^{MS}
4202 Matte Black	2882384 \$1,299 ^{MS}	2883221 \$1,404 ^{MS}	2883204 \$1,299 ^{MS}	2881344 \$1,299 ^{MS}	2884268 \$1,309 ^{MS}	2884261 \$1,394 ^{MS}
4203 BEADLOCK Matte Black BEADLOCKS SOLD SEPARATELY				2881386 \$1,629 ^{MS}		
4204 Accent	2882385 \$1,404 ^{MS}	2883222 \$1,524 ^{MS}	2883205 \$1,404 ^{MS}	2881355 \$1,404 ^{MS}	2884270 \$1,419 ^{MS}	2884263 \$1,469 ^{MS}
4204 Matte Black	2882386 \$1,299 ^{MS}	2883223 \$1,404 ^{MS}		2881356 \$1,299 ^{MS}	2884271 \$1,309 ^{MS}	2884264 \$1,364 ^{MS}
4205 Luster				2881371 \$1,404 ^{MS}		
4205 Matte Black	2882387 \$1,299 ^{MS}	2883224 \$1,404 ^{MS}	2883207 \$1,299 ^{MS}	2881372 \$1,299 ^{MS}	2884269 \$1,299 ^{MS}	2884262 \$1,364 ^{MS}
4301 BEADLOCK Accent BEADLOCKS PRE-MOUNTED				2883213 \$1,734 ^{MS}		
4301 BEADLOCK Matte Black BEADLOCKS PRE-MOUNTED				2883212 \$1,629 ^{MS}		

15"

50-SERIES

TRAIL

ATTACK 2.0 28" 3,000 MI/4,826 km

CRAWLER XG 28" 3,000 MI/4,826 km

DESERT/ROCK

5201 Accent	2883160 \$1,469 ^{MS}	2883188 \$1,469 ^{MS}
5201 Matte Black	2883159 \$1,354 ^{MS}	2883187 \$1,354 ^{MS}
5202 Accent	2883158 \$1,469 ^{MS}	2883186 \$1,469 ^{MS}
5202 Matte Black	2883157 \$1,354 ^{MS}	2883185 \$1,354 ^{MS}
5203 BEADLOCK Accent BEADLOCKS SOLD SEPARATELY	2883154 \$1,679 ^{MS}	2883182 \$1,679 ^{MS}
5204 Matte Black	2883155 \$1,354 ^{MS}	2883183 \$1,354 ^{MS}
5301 BEADLOCK Accent BEADLOCKS PRE-MOUNTED	2883162 \$1,784 ^{MS}	2883190 \$1,784 ^{MS}
5301 BEADLOCK Matte Black BEADLOCKS PRE-MOUNTED	2883161 \$1,679 ^{MS}	2883189 \$1,679 ^{MS}

2 WAYS TO PURCHASE

INDIVIDUAL WHEELS & TIRES
- OR -
COMPLETE SETS AS LISTED

visit Polaris.com/ProArmorRANGER
TO BUILD YOUR CUSTOM SET & VERIFY FITMENT

Exclusively at Polaris Authorized Dealers
or Polaris.com/ProArmorRANGER

BACKCOUNTRY/TRAIL

DUAL-THREAT 26" 3,000 MI/4,826 km

DUAL-THREAT 29" 3,000 MI/4,826 km

ATTACK 26" 3,000 MI/4,826 km

X TERRAIN 27" 3,000 MI/4,826 km

X TERRAIN 29" 3,000 MI/4,826 km

2883138 \$1,354 ^{MS}	2883146 \$1,524 ^{MS}	2882390 \$1,299 ^{MS}	2889966 \$1,299 ^{MS}	2889976 \$1,379 ^{MS}
2883139 \$1,249 ^{MS}	2883147 \$1,404 ^{MS}	2882391 \$1,194 ^{MS}	2889967 \$1,199 ^{MS}	2889977 \$1,279 ^{MS}
2883140 \$1,354 ^{MS}	2883148 \$1,524 ^{MS}	2881335 \$1,299 ^{MS}	2889968 \$1,299 ^{MS}	2889978 \$1,379 ^{MS}
2883141 \$1,249 ^{MS}	2883149 \$1,404 ^{MS}	2881336 \$1,194 ^{MS}	2889969 \$1,199 ^{MS}	2889979 \$1,279 ^{MS}
		2881381 \$1,354 ^{MS}	2889972 \$1,499 ^{MS}	2889982 \$1,579 ^{MS}
2883142 \$1,354 ^{MS}	2883150 \$1,524 ^{MS}	2881347 \$1,299 ^{MS}	2889973 \$1,199 ^{MS}	2889983 \$1,279 ^{MS}
2883143 \$1,249 ^{MS}	2883151 \$1,404 ^{MS}	2881348 \$1,194 ^{MS}	2889974 \$1,099 ^{MS}	2889984 \$1,179 ^{MS}
		2881359 \$1,299 ^{MS}		
2883144 \$1,249 ^{MS}	2883152 \$1,404 ^{MS}	2881360 \$1,194 ^{MS}	2889975 \$1,099 ^{MS}	2889985 \$1,179 ^{MS}
2883217 \$1,679 ^{MS}	2883219 \$1,849 ^{MS}		2889970 \$1,499 ^{MS}	2889980 \$1,579 ^{MS}
2883216 \$1,574 ^{MS}	2883218 \$1,734 ^{MS}		2889971 \$1,399 ^{MS}	2889981 \$1,479 ^{MS}

REPLACEMENT CAPS

POLARIS CAPS		
LUSTER	ALL WHEELS EXCEPT 5204 & 5203 BEADLOCK	1521509-410 \$14 ^{MS}
MATTE BLACK		1521509-521 \$14 ^{MS}
LUSTER	5203 BEADLOCK	1522243-410 \$24 ^{MS}
MATTE BLACK		1522243-458 \$24 ^{MS}
HD MATTE BLACK	ALL WHEELS	5457498-458 \$22 ^{MS}
PRO ARMOR CAPS		
LUSTER	ALL WHEELS EXCEPT 5204 & 5203 BEADLOCK	5453209-410 \$14 ^{MS}
MATTE BLACK		5453209-458 \$14 ^{MS}
MATTE BLACK	5204	1523063-458 \$14 ^{MS}
LUSTER	5203 BEADLOCK	1523015-410 \$14 ^{MS}
MATTE BLACK		1523015-458 \$14 ^{MS}



TIRE SEALANT P. 104

• 30 OZ. • 2830484 • \$20^{MS}
• 1 GALLON • 2830485 • \$72^{MS}

• 5 GALLONS • 2830486 • \$298^{MS}
• 5 GALLONS PUMP • 2830487 • \$133^{MS}

LUG NUTS

LUG NUTS REQUIRED

12mm x 1.5 SPLINED LUG NUTS		
16 LUG NUTS WITH WRENCH		2879332 \$39 ^{MS}
4 LUG NUTS WITHOUT WRENCH	ALL POLARIS RANGER 3-SEAT & CREW MODELS	2879331 \$14 ^{MS}
SPLINED LUG WRENCH		2204966 \$9 ^{MS}
3/8" - 24 HEX LUG NUTS		
16 HEX LUG NUTS	ALL POLARIS RANGER 570 20-21 MODELS	2877409 \$34 ^{MS}
4 HEX LUG NUTS		2876754 \$14 ^{MS}

COMMON ACCESSORIES
CONNECTED TECHNOLOGY
ELECTRICAL ACCESSORIES
COOLERS
HUNT
COLD WEATHER
PLUMBING
LIGHTS
WHEELS & TIRES

WHEELS

15"

50-SERIES

5201

WEIGHT: 17.1 lbs LOAD RATING: 1,300 lbs OFFSET: +4

ACCENT: FRONT/REAR 15" x 7" 1523184-266 **\$139**^{MS}
 MATTE BLACK: FRONT/REAR 15" x 7" 1523184-458 **\$119**^{MS}

5202

WEIGHT: 17.8 lbs LOAD RATING: 1,300 lbs OFFSET: +4

ACCENT: FRONT/REAR 15" x 7" 1523102-266 **\$139**^{MS}
 MATTE BLACK: FRONT/REAR 15" x 7" 1523102-458 **\$119**^{MS}

5203 BEADLOCK

WEIGHT: 16 lbs LOAD RATING: 1,300 lbs OFFSET: +38

MATTE BLACK: FRONT/REAR 15" x 7" 1522435-458 **\$249**^{MS}

5204

WEIGHT: 13.5 lbs LOAD RATING: 1,300 lbs OFFSET: +55

MATTE BLACK: FRONT/REAR 15" x 7" 1522550-458 **\$199**^{MS}

5301 BEADLOCK

WEIGHT: 17 lbs LOAD RATING: 1,600 lbs OFFSET: +38

ACCENT: FRONT/REAR 15" x 7" 1523282 **\$239**^{MS}
 MATTE BLACK: FRONT/REAR 15" x 7" 1523266 **\$219**^{MS}

LUG NUTS

○ LUG NUTS REQUIRED

SEE P. 65



14"

40-SERIES

4201

Front WEIGHT: 13 lbs LOAD RATING: 900 lbs OFFSET: +9
 Rear WEIGHT: 14 lbs LOAD RATING: 1,300 lbs OFFSET: -9

ACCENT: FRONT 14" x 7" 1522956-266 **\$154**^{MS}
 REAR 14" x 8" 1522957-266 **\$169**^{MS}
 MATTE BLACK: FRONT 14" x 7" 1522956-458 **\$129**^{MS}
 REAR 14" x 8" 1522957-458 **\$139**^{MS}

4202

Front WEIGHT: 12.75 lbs LOAD RATING: 900 lbs OFFSET: +4
 Rear WEIGHT: 13.5 lbs LOAD RATING: 1,300 lbs OFFSET: -9

ACCENT: FRONT 14" x 7" 1522544-266 **\$154**^{MS}
 REAR 14" x 8" 1522545-266 **\$169**^{MS}
 MATTE BLACK: FRONT 14" x 7" 1522544-458 **\$129**^{MS}
 REAR 14" x 8" 1522545-458 **\$139**^{MS}

4203 BEADLOCK

Front WEIGHT: 13 lbs LOAD RATING: 900 lbs OFFSET: +4
 Rear WEIGHT: 14.5 lbs LOAD RATING: 1,300 lbs OFFSET: -9

MATTE BLACK: FRONT 14" x 7" 1522238-458 **\$229**^{MS}
 REAR 14" x 8" 1522239-458 **\$229**^{MS}

4204

Front WEIGHT: 13 lbs LOAD RATING: 900 lbs OFFSET: +4
 Rear WEIGHT: 14 lbs LOAD RATING: 1,300 lbs OFFSET: -9

ACCENT: FRONT 14" x 7" 1522546-266 **\$154**^{MS}
 REAR 14" x 8" 1522547-266 **\$154**^{MS}
 MATTE BLACK: FRONT 14" x 7" 1522546-458 **\$129**^{MS}
 REAR 14" x 8" 1522547-458 **\$129**^{MS}

4205

Front WEIGHT: 10.5 lbs LOAD RATING: 900 lbs OFFSET: +4
 Rear WEIGHT: 12.5 lbs LOAD RATING: 1,300 lbs OFFSET: -9

MATTE BLACK: FRONT 14" x 7" 1521507-521 **\$119**^{MS}
 REAR 14" x 8" 1521508-521 **\$129**^{MS}
 LUSTER: FRONT 14" x 7" 1521507-410 **\$154**^{MS}
 REAR 14" x 8" 1521508-410 **\$159**^{MS}

4301 BEADLOCK

WEIGHT: 16 lbs LOAD RATING: 1,600 lbs OFFSET: +38

ACCENT: FRONT/REAR 14" x 7" 1523284 **\$219**^{MS}
 MATTE BLACK: FRONT/REAR 14" x 7" 1523283 **\$209**^{MS}

HD DUAL BEADLOCK

WEIGHT: 40 lbs LOAD RATING: 1,600 lbs OFFSET: +38

MATTE BLACK: FRONT/REAR 14" x 7" 1524022-458 **\$283**^{MS}



14" FORGED BEADLOCK RINGS

○ Machined Only used on 4203 Beadlock & HD Dual Beadlock 1522244-266 **\$124**^{MS}
 ○ Matte Black - Replacement Only used on 4301 Beadlock & HD Dual Beadlock 1523146-458 **\$59**^{MS}

15" FORGED BEADLOCK RINGS

○ Machined Only used on 5202 Beadlock 1522240-266 **\$159**^{MS}
 ○ Matte Black - Replacement Only used on 5301 Beadlock 1523147-458 **\$64**^{MS}

KNOW YOUR WHEELS

STEP 1: SELECT YOUR SERIES

- 4 - 40-SERIES
- 5 - 50-SERIES

STEP 2: CHOOSE YOUR LOAD RATING

- 1 - <800 lbs
- 2 - 801 - 1,300 lbs
- 3 - 1,301 - 1,600+ lbs

STEP 3: PICK YOUR STYLE

- OFFSET / BEADLOCK / COLOR
- INCREASE OFFSET FROM STOCK - NARROWER STANCE
- DECREASE OFFSET FROM STOCK - WIDER STANCE



HD PARTS
P. 100



MAKE IT YOURS

CUSTOMIZE YOUR RANGER SP 570 AND GET MORE DONE with Polaris Engineered Accessories. Outfit your RANGER based on your riding preferences for added comfort, maximized storage, and more.

SHOP ALL RANGER ACCESSORIES AT POLARIS.COM/ShopRANGER

RANGER SP 570 HUNT



2884106	LOCK & RIDE Kolpin Stronghold Auto-Latch Boot Mount	P. 48	2889181	Rock Guard with Step - Crew	P. 75
2882036	Kolpin Stronghold Gun Boot XL	P. 48	2885087	Rear Brushguard	P. 75
2889791	Pro Armor 33" Combo LED Light Bar	P. 57	2885096	Polaris Pro HD 4,500 lb. Winch with Rapid Rope Recovery	P. 75
2885078	Poly Crew Sport Roof	P. 70	2885088	Front Hood Storage Rack	P. 77



RANGER SP 570 LANDOWNER

2885077	Poly 2-Seat Sport Roof	P. 70	2885096	Polaris Pro HD 4,500 lb. Winch with Rapid Rope Recovery	P. 75
2889187	Convex Weatherproof Rear View Mirror	P. 74	2889189	Cargo Bed Mat	P. 76
2889243	Side View Mirrors - ROPS-Mounted	P. 74	2889199	LOCK & RIDE Storage Box	P. 76



RANGER SP 570 FARM

2885077	Poly 2-Seat Sport Roof	P. 70	2885087	Rear Brushguard	P. 75
2889187	Convex Weatherproof Rear View Mirror	P. 74	2885095	Polaris HD 3,500 lb. Winch	P. 75
2889243	Side View Mirrors - ROPS-Mounted	P. 74	2889182	LOCK & RIDE Tip-Down Headache Rack	P. 76
2885084	Upper Front Brushguard	P. 75	2889189	Cargo Bed Mat	P. 76



RANGER CREW SP 570 TRAIL

2889791	Pro Armor 33" Combo LED Light Bar	P. 57	2889243	Side View Mirrors - ROPS-Mounted	P. 74
2885078	Poly Crew Sport Roof	P. 70	2889181	Rock Guard with Step - Crew	P. 75
2885080	LOCK & RIDE Full Glass Windshield	P. 72	2885084	Upper Front Brushguard	P. 75
2879965	LOCK & RIDE Rear Panel - Glass	P. 73	2885087	Rear Brushguard	P. 75
2885083	Windshield Wiper & Washer Kit	P. 74	2889183	LOCK & RIDE Bed Extender/Divider	P. 76
2889187	Convex Weatherproof Rear View Mirror	P. 74			

ROOFS



SEALED COVERAGE



REDUCE STANDING WATER



**LOCK & RIDE
EASY AND FAST INSTALLATION**

POLARIS ENGINEERED ADVANTAGES

GLASS VS POLY

- Water run-off
- Mounting features: easily add accessories & lighting
- Liner ready
- Lightweight

- Heavy duty/durable
- Low profile
- Unique style

SHIELD AGAINST DRIVING RAIN OR THE BLISTERING SUN.

Choose from poly or steel and know that you are protected from the elements with a seamless integrated roof.

POLY

Lightweight, durable and impact-resistant. A poly roof can take the abuse of a tight trail and still protect.



SPORT ROOF - POLY

- Offers reliable protection from the sun and rain
- Lightweight, durable polyethylene construction
- Simple one-time installation

- **2-SEAT BLACK** • 2885077 • **\$419^{MS}**
SP 570 '22-23
- **CREW BLACK** • 2885078 • **\$679^{MS}**
CREW SP 5770 '22-23

PREMIUM ROOF LINER

- Cut in-cab noise by 60% at idle and by 40% at 20 mph
- One-piece liner attaches quickly and securely using push darts
- Adds premium comfort and quieter cab ride
- **2-SEAT (shown)** • 2885093 • **\$194^{MS}**
SP 570 '22-23
- **CREW** • 2885094 • **\$514^{MS}**
CREW SP 570 '22-23

DOORS



PREMIUM FEATURES



UNPRECEDENTED VENTILATION OPTIONS



EASY AND FAST INSTALLATION

POLARIS ENGINEERED ADVANTAGES

	POLY DOORS	CANVAS DOORS
FRONT DOORS (SET OF 2) SP 570 '22-23, CREW SP 570 '22-23	<p>CRANK WINDOW Has manual crank windows for airflow adjustment in the cab with a fully finished black interior and exterior panels. Has a steel tube frame with a full 360 degree seal to keep out dust and rain.</p> <p>Manual Crank Window Doors 2885073 • \$3,029^{MS} SHOWN WITH EXTERIOR DOOR ACCENT PANEL 2889389-795</p>	<p>ZIP WINDOW Heavy-duty 23-oz durable protection with adjustable zipper ventilation and see-through bottom panel. Powder-coated steel rod door frames provide strength and enhance fit and finish.</p> <p>Zip Window Doors 2885075 • \$899^{MS}</p>
REAR DOORS (SET OF 2) CREW SP 570 '22-23	<p>Manual Crank Window Doors 2885074 • \$2,799^{MS} SHOWN WITH EXTERIOR DOOR ACCENT PANEL 2889390-795</p>	<p>Zip Window Doors 2885076 • \$899^{MS}</p>

EXTERIOR DOOR ACCENT PANELS

- Replace stock gloss black accent panels
- Painted plastic and clear-coated for UV protection
- Install easily with a single screw
- Comes as a pair
- Compatible with Poly doors only



FRONT REAR	<p>Ghost Gray 2889389-728 • \$99^{MS} 2889390-728 • \$99^{MS}</p>	<p>Polaris Pursuit Camo 2889391-587 • \$119^{MS} 2889392-587 • \$119^{MS}</p>	<p>Sagebrush Green Non-Metallic 2889389-560 • \$99^{MS} 2889390-560 • \$99^{MS}</p>	<p>Polaris Blue Non-Metallic 2889389-795 • \$99^{MS} 2889390-795 • \$99^{MS}</p>
-------------------	--	--	--	---

WINDSHIELDS & REAR PANELS

GLASS VS POLY

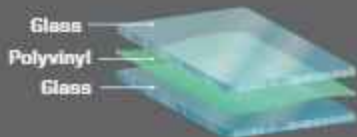

- Superior optical clarity (automotive level)
- Scratch-resistant
- Curved to fit, seals tight
- Cold weather / heavy duty
- Wiper ready (windshield only)

- Lightweight, flexible, easy to store/remove
- Impact-resistant
- Tight seal keeps out rain and dust

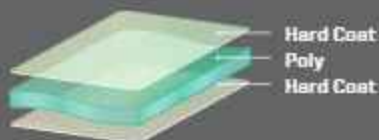

LOCK & RIDE

REVOLUTIONARY INSTALLATION



AIRTIGHT GASKET SEAL



VENTING OPTIONS

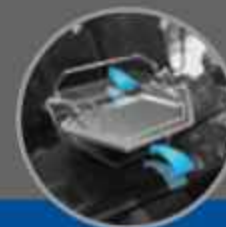

MULTI-FUNCTION FEATURES



POLARIS ENGINEERED ADVANTAGES

WINDSHIELDS



Open

FULL TIP-OUT WINDSHIELD - GLASS

- Tip-out design offers three positions: open, closed and vented
- Gas shocks assist in easy opening and closing
- 360° gasket for reliable protection and comfort
- Scratch-resistant automotive-style curved glass
- Interior sound dampening and optimized visibility

2885079 • \$1,149^{MS}
SP 570 '22-23, CREW SP 570 '22-23



WIPER AVAILABLE
P. 74

FULL GLASS WINDSHIELD - CLEAR

- Scratch-resistant, curved laminate safety glass
- Protects against wind, rain and other hazardous debris
- UV-blocking interlayer and 360° gasket seal

2885080 • \$799^{MS}
SP 570 '22-23, CREW SP 570 '22-23



LOCK & RIDE
FULL WINDSHIELD - POLY **TOP SELLER**

- Durable, optical-grade, .236"-thick polycarbonate offers outstanding rider protection and visibility
- Windshield has minimal perimeter framework for full visibility

2883318 • \$399^{MS}
SP 570 '22-23, CREW SP 570 '22-23



LOCK & RIDE
HALF WINDSHIELD - POLY

- Strong, durable polycarbonate half windshield delivers a combination of protection and airflow into the cab
- Half windshield offers protection from rain, sleet, spray, and off-road hazards

2883320 • \$199^{MS}
SP 570 '22-23, CREW SP 570 '22-23



LOCK & RIDE
VENTED WINDSHIELD - HARD COAT POLY

- Frameless design for maximum visibility
- Added vents for airflow on a hot day or defrosting on a cold day

2883342 • \$564^{MS}
SP 570 '22-23, CREW SP 570 '22-23



LOCK & RIDE
FULL WINDSHIELD - HARD COAT POLY **TOP SELLER**

- Durable, optical-grade, .236"-thick polycarbonate offers outstanding rider protection and visibility
- Windshield has minimal perimeter framework for full visibility

2883319 • \$529^{MS}
SP 570 '22-23, CREW SP 570 '22-23

REAR PANELS



LOCK & RIDE
REAR PANEL - GLASS **TOP SELLER**

- Durable, tempered laminate glass provides a high level of scratch resistance

2879965 • \$399^{MS}
SP 570 '22-23, CREW SP 570 '22-23



LOCK & RIDE
REAR PANEL - POLY **TOP SELLER**

- Strong, .236"-thick polycarbonate provides outstanding impact and scratch resistance

2879812 • \$299^{MS}
SP 570 '22-23, CREW SP 570 '22-23

HARD COAT POLY | 30x MORE SCRATCH-RESISTANT



REDUCE IN-CAB DUST SWIRL BY ADDING A REAR PANEL

With a windshield and roof installed, turbulent air develops behind the cab. Add a rear panel to reduce dust intrusion from this swirl.

AUDIO



JBL® DASH AUDIO KIT

- System mounts into pre-designated locations in the vehicle dash
- Complete UTV audio solution gives your vehicle a performance-ready sound system
- Includes four off-road grade, water- and dust-proof speakers, and one head unit
- Head unit features AM/FM tuner, USB input and Bluetooth® compatibility for wireless streaming



▶ 2885081 • \$699**
SP 570 '22-'23

POLARIS RIDECOMMAND SEE P. 42 FOR MORE INFORMATION

7" DISPLAY POWERED BY RIDE COMMAND*

▶ 2884072 • \$1,594**
SP 570 '22-'23
SPEAKERS NOT INCLUDED



*Due to ongoing supply chain issues, there may be delayed or limited availability of this product as an accessory add-on.

CONVENIENCE FEATURES

CAB SEAL KIT

- Seal out dust from your UTV cab
- Reduces dust from getting on dash and seat

▶ 2889201 • \$179**

SP 570 '22-'23, CREW SP 570 '22-'23
(INCLUDED WITH PREMIUM DOORS)

FRONT PULSE BAR AND HARNESS

- This kit is needed to install any electrical accessories to a base vehicle

▶ 2-SEAT • 2889185 • \$84**

SP 570 '22-'23, CREW SP 570 '22-'23

▶ CREW • 2889568 • \$84**

CREW SP 570 '22-'23

ELECTRONIC POWER STEERING KIT**

- Smoothest, most powerful electronic power steering available for your Polaris RANGER
- Variable assist for easier steering at lower speeds
- Greater responsiveness at higher speeds
- Front PULSE Bar and Harness required, sold separately

▶ 2889464 • \$1,379**

▶ EPS HARNESS KIT • 2890069 • \$149**

SP 570 '22-'23, CREW SP 570 '22-'23

HORN KIT

- Adds a warning horn to console area of vehicle

▶ 2889160 • \$94**

SP 570 '22-'23, CREW SP 570 '22-'23
SP 570 NON-PREMIUM AND NON-NORTHSTAR MODELS REQUIRE FRONT PULSE BAR AND HARNESSES 2889185

DOME LIGHT

- LED Dome light provides optimal visibility in the cab
- Easy to install

▶ 2889159 • \$109**

SP 570 '22-'23, CREW SP 570 '22-'23
SP 570 NON-PREMIUM AND NON-NORTHSTAR MODELS REQUIRE FRONT PULSE BAR AND HARNESSES 2889185

FLOOR MATS - FRONT

- Protects floors from dirt and wear
- Textured, non-slip surface

▶ 2889186 • \$124**

SP 570 '22-'23, CREW SP 570 '22-'23

SPEEDKEY

▶ 2879988 • \$319**

SP 570 '22-'23, CREW SP 570 '22-'23

CONVENIENCE FIELD TESTED INTERIOR

ADD SUPERIOR ALL-WEATHER FUNCTIONALITY

and comfort to your RANGER with premium Polaris Engineered Accessories. Keep warm on the coldest of days with a heater kit and improve visibility with a Windshield Wiper and Washer System or Large Rear View Mirror.



HEATER KIT

- Climate control for the cab of your off-road vehicle
- Total of four dash mounted vents with two positioned for defrosting the windshield and the other two for heating the cab
- Simple, dash-mounted controls
- Manually operated vents for airflow control

▶ 2885082 • \$1,099**

SP 570 '22-'23, CREW SP 570 '22-'23
SP 570 SPORT MODELS REQUIRES FRONT PULSE BAR AND HARNESSES 2889185



CONVEX WEATHERPROOF REAR VIEW MIRROR

- Convex design for a broader view of traffic
- Durable, weatherproof construction
- Mount the bolts into your choice of pre-designated mounting locations
- Compatible with roof, windshield, and other accessories

▶ 2889187 • \$64**

SP 570 '22-'23, CREW SP 570 '22-'23



WINDSHIELD WIPER & WASHER KIT

- Helps clear hazardous dirt, rain and debris from your windshield

▶ 2885083 • \$14**

SP 570 '22-'23, CREW SP 570 '22-'23
SP 570 SPORT MODELS REQUIRES FRONT PULSE BAR AND HARNESSES 2889185



SIDE VIEW MIRRORS

▶ DOOR MOUNTED (shown) • 2889241 • \$174**

▶ ROPS-MOUNTED • 2889243 • \$174**

SP 570 '22-'23, CREW SP 570 '22-'23

PROTECTION



UPPER FRONT BRUSHGUARD

- Made from tubular steel and provides additional protection for front fenders and headlights
- Attaches to stock front bumper
- Durable, scratch-resistant, black powder-coat finish

▶ 2885084 • \$249**

SP 570 '22-'23, CREW SP 570 '22-'23



REAR BRUSHGUARD

- Made from tubular steel and provides additional protection for taillights
- Durable, scratch-resistant, black powder-coat finish
- Reliably enhances back-end protection of vehicle

▶ 2885087 • \$229**

SP 570 '22-'23, CREW SP 570 '22-'23



ROCK GUARD WITH STEP

- Reliable, hard-working protection for edges of vehicle
- Mounts directly to the frame, instead of underneath, for maximum ground clearance

▶ 2-SEAT (shown) • 2889180 • \$309**

SP 570 '22-'23

▶ CREW • 2889181 • \$409**

CREW SP 570 '22-'23



A-ARM GUARDS

- Valuable, reliable protection for vital front suspension components exposed to the rigors of off-road environments
- Strong, durable, lightweight polyethylene construction withstands off-road impacts to protect the A-Arms

▶ FRONT (shown) • 2885097 • \$209**

▶ REAR • 2880551 • \$209**

SP 570 '22-'23, CREW SP 570 '22-'23

WINCHES

FEATURES & BENEFITS	PRO PRO HEAVY DUTY SERIES	HD HEAVY DUTY SERIES	
RAPID ROPE RECOVERY Retrieve cable 5x as fast as standard mode on other Polaris winches. Get back to riding or complete your task quicker.	✓	NOT AVAILABLE	
AUTO STOP TECHNOLOGY Auto Stop technology protects and extends the life of your winch by automatically stopping the winch at the end of pull to prevent over-spooling.	✓	ADD AUTO STOP UPGRADE 2881693 • \$109** SYNTHETIC ROPE REQUIRED	
SYNTHETIC ROPE Lightweight, extremely strong and flexible 50 ft long rope stands up to any tough job.	✓	ADD SYNTHETIC ROPE 2878888 • \$84**	
WIRELESS REMOTE Operate your winch wirelessly from within 50 ft of the vehicle.	WIRELESS STANDARD, WIRED OPTION	WIRED STANDARD, ADD WIRELESS REMOTE 2879316 • \$139**	
MODEL	4,500 LB.	3,500 LB.	ADD REQUIRED CABLES
SP 570 '22-'23 CREW SP 570 '22-'23	2885096 \$849.99	2885095 \$469.99	2-SEAT & CREW MODELS: 2889185 \$84.99

UPGRADE YOUR CONTROLS HD OR PRO HD WINCHES

- ### WIRED REMOTE CONTROL
- Must order remote handle and socket together
 - ▶ REMOTE HANDLE 4013466 • \$68**
 - ▶ SOCKET 4014228 • \$49**

- ### POWER CONTROLLER
- Control your winch and plow hydraulics directly from the shift knob
 - ▶ 2879227 • \$49**
SP 570 '22-'23



**Check with your local dealer for availability.

STORAGE



LOCK & RIDE

Exclusive and available on all Polaris vehicles, Lock & Ride accessories let you quickly change from one task to another with hundreds of options.

WITH THE FLIP OF A LEVER, LOCK & RIDE PLUNGERS USE OUTWARD PRESSURE TO EXPAND FOR A SECURE FIT.



LOCK & RIDE STORAGE BOX

- Provides enough room to store all the tools you need to get the job done
 - Internal organizational dividers keep gear from rolling around
 - Easily detaches from vehicle
- ▶ 2889199 • \$334 ^{MS}
SP 570 '22-23, CREW SP 570 '22-23



LOCK & RIDE TIP-DOWN HEADACHE RACK

- Provides extreme cargo versatility to your UTV
 - Strong steel tube construction for maximum durability
 - Installs and removes easily utilizing Lock & Ride technology
- ▶ 2889182 • \$389 ^{MS}
SP 570 '22-23, CREW SP 570 '22-23



LOCK & RIDE BED EXTENDER/DIVIDER

- Increase your cargo capacity and UTV storage
 - Extend the cargo bed or divide cargo within the bed
 - Lock & Ride technology for easy install without tools
 - Made from durable steel and powder-coated finish
- ▶ 2889183 • \$259 ^{MS}
SP 570 '22-23, CREW SP 570 '22-23



CARGO BED MAT

- Protects cargo box, reduces drivetrain noise, and keeps cargo more secure with non-slip design
 - Thick (3.18 mm) rubber mat construction
- ▶ 2889189 • \$124 ^{MS}
SP 570 '22-23, CREW SP 570 '22-23



LOCK & RIDE FRONT HOOD STORAGE RACK

- Increases load-carrying capacity and protects against brush and debris
 - Steel construction with a durable powder-coated finish
 - Lock & Ride functions for easy install, on and off maneuvering of the basket, and under-hood access
 - Weight Capacity: 100 lbs.
- ▶ 2885088 • \$349 ^{MS}
SP 570 '22-23, CREW SP 570 '22-23



FIRE EXTINGUISHER HOLDER

- Quick-release strap allows for easy access
- ▶ 2882158 • \$89 ^{MS}
SP 570 '22-23, CREW SP 570 '22-23



RIDE & REPAIR ESSENTIALS KIT

- ▶ 2881207 • \$109 ^{MS}
SP 570 '22-23, CREW SP 570 '22-23



LOCK & RIDE D-RINGS ^{SP 570}

- The most versatile Lock & Ride accessory - add as many as you need to secure your cargo with bungee cords or straps
- ▶ 2881545 • \$34 ^{MS}
SP 570 '22-23, CREW SP 570 '22-23



LOCK & RIDE CHAINSAW MOUNT

- ▶ 2879354 • \$139 ^{MS}
SP 570 '22-23, CREW SP 570 '22-23



LOCK & RIDE TOOL RACK

- Attach on the inside or outside of the cargo bed
- ▶ 2881533 • \$259 ^{MS}
SP 570 '22-23, CREW SP 570 '22-23

STRAPS

1.5" x 15' 5,500 LB. RATCHET STRAP

- Heavy-duty webbing
 - 2 Pack
- ▶ 2884031 • \$44 ^{MS}



LOCK & RIDE QUICKSTRAP

- The quickest and most secure way to mount Polaris accessories
 - Sold as a pair
- ▶ 2882187 • \$44 ^{MS}
ALL COOLERS, RANGER CARGO BOXES



2" x 20' 10,000 LB. RATCHET STRAP

- Heavy-duty webbing
- ▶ 2884032 • \$34 ^{MS}



DO MORE:



COOLERS
P. 46



HUNT
P. 48

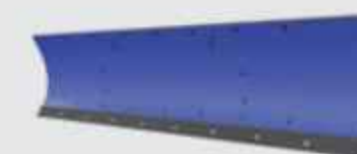

COLD WEATHER
P. 50



LIGHTING
P. 56

MAKE IT YOURS

WORK HARD AND GET IT DONE

with Polaris Engineered Accessories for your RANGER. Start with the ultimate in all-season performance and comfort with the best cab components in the industry. Find everything you need to outfit your RANGER for the task at hand.

RANGER 570 HUNT

2882036	Kolpin Stronghold Gun Boot XL	P. 48
2885077	Poly 2-Seat Sport Roof	P. 80
2881784	LOOK & PICK Tip-Out Windshield - Glass	P. 82
2882238	Polaris Pro HD 4,500 lb. Winch	P. 85



RANGER 570 WORK

2885077	Poly 2-Seat Sport Roof	P. 80
2882247	Hinged Window Doors - Poly	P. 81
2881784	LOOK & PICK Tip-Out Windshield - Glass	P. 82
2882238	Polaris Pro HD 4,500 lb. Winch	P. 85



RANGER CREW 570-4 EPS RANCH

2883424	Polaris Northstar Cooler - 30 Quart	P. 46
2885078	Poly Sport Roof - Crew	P. 80
2879963	LOOK & PICK Canvas Door Set	P. 81
2881783	Glass Full Windshield, Clear	P. 82
2881533	LOOK & PICK Tool Rack	P. 87



RANGER 500 TRAIL

2883425	Polaris Northstar Cooler - 60 Quart	P. 46
2885077	Poly 2-Seat Sport Roof	P. 80
2883320	LOOK & PICK Half Windshield - Poly	P. 83

ROOFS



SEALED
COVERAGE

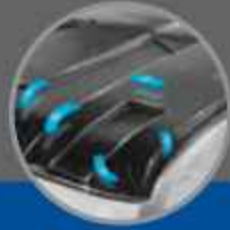

REDUCE
STANDING
WATER



LOCK & RIDE
EASY AND FAST
INSTALLATION

POLARIS ENGINEERED
ADVANTAGES

POLY FEATURES

- Water run-off
- Mounting features: easily add accessories & lighting
- Liner ready
- Lightweight

SHIELD AGAINST DRIVING RAIN OR THE BLISTERING SUN.

Know that you are protected from the elements with a seamless integrated roof. Poly is lightweight, durable and impact-resistant. A poly roof can take the abuse of a tight trail and still protect.

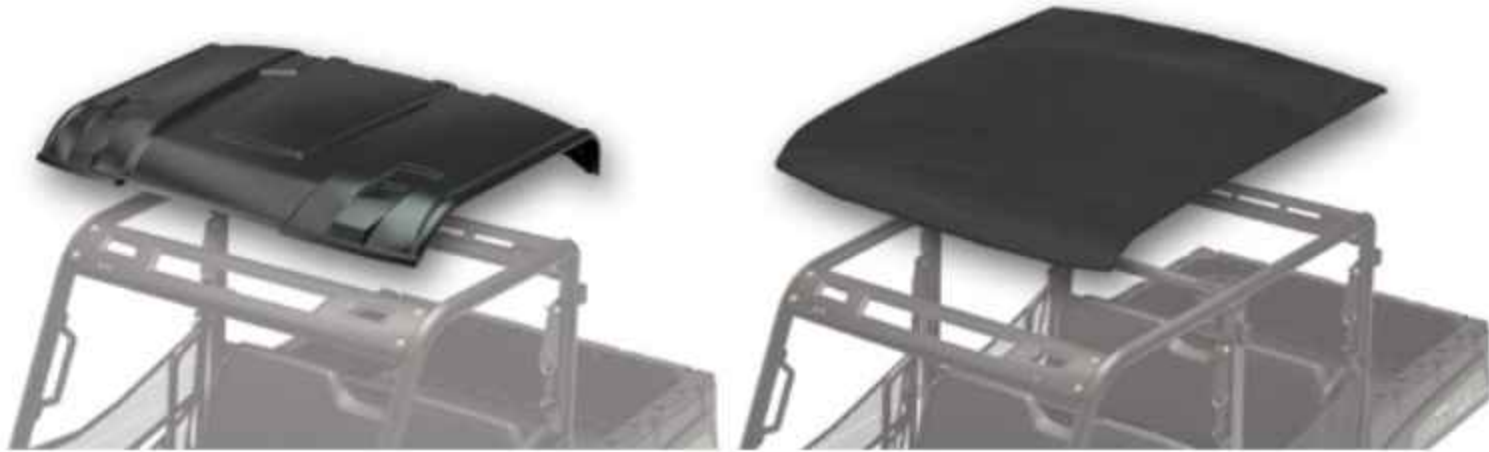

SPORT ROOF - POLY

- Provides shade, superior overhead protection
- Tough injection-molded design resists distortion from the elements
- Polaris Pursuit Camo offers effective visual camouflage in the field

- 2-SEAT BLACK • 2885077 • ***419**^{MS}
EV '15-23, 570 '15-21, 500 '17-23
- CREW BLACK • 2885078 • ***679**^{MS}
CREW 570-4 '15-21

DOORS



PREMIUM
FEATURES



UNPRECEDENTED
VENTILATION
OPTIONS



EASY AND FAST
INSTALLATION

POLARIS ENGINEERED
ADVANTAGES

	POLY DOORS	CANVAS DOORS
FRONT DOORS (SET OF 2) EV '15-23, CREW 570-4 '15-21, 570 '15-21, 500 '17-23	HINGED WINDOW A premium, door offering hinged window for customizable ventilation in the cab.  Hinged Window - Poly Doors - Black 2882247 • *2,919 ^{MS}	ZIP WINDOW Lightweight, durable protection with adjustable zipper ventilation and see-through bottom panel.  Zip Window Doors - Canvas - Black 2879963 • *999 ^{MS}
REAR DOORS (SET OF 2) CREW 570-4 '15-21		 Zip Window Doors - Rear - Canvas - Black 2879964 • *999 ^{MS}



WINDSHIELDS & REAR PANELS

GLASS VS POLY

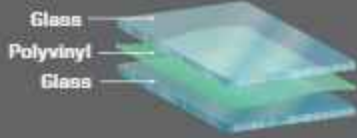

- Superior optical clarity (automotive level)
- Scratch-resistant
- Curved to fit, seals tight
- Cold weather / heavy duty
- Wiper ready (windshield only)

- Lightweight, flexible, easy to store/remove
- Impact-resistant
- Tight seal keeps out rain and dust

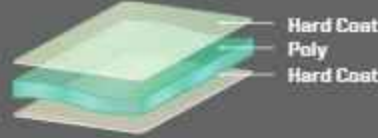

LOCK & RIDE

REVOLUTIONARY INSTALLATION



AIRTIGHT GASKET SEAL



VENTING OPTIONS



MULTI-FUNCTION FEATURES



POLARIS ENGINEERED ADVANTAGES

WINDSHIELDS



LOCK & RIDE TIP-OUT WINDSHIELD - GLASS

- Made of strong, optical-grade laminate safety glass
- Provides optimal visibility and the best protection from wind, inclement weather and off-road hazards
- Minimal perimeter framework for a low profile and full visibility
- Tip-out feature adjusts the windshield to an open position to enjoy airflow in the cab

• 2881784 • \$1,179^{MS}
EV '15-23, CREW 570-4 '15-21, 570 '15-21, 500 '17-23

LOCK & RIDE FULL WINDSHIELD - GLASS

- Provides the highest level of scratch resistance

• 2881783 • \$729^{MS}
EV '15-23, CREW 570-4 '15-21, 570 '15-21, 500 '17-23

LOCK & RIDE FULL WINDSHIELD - POLY

- Durable, optical-grade, .236"-thick polycarbonate offers outstanding rider protection and visibility
- Windshield has minimal perimeter framework for full visibility

• 2883318 • \$399^{MS}
EV '15-23, CREW 570-4 '15-21, 570 '15-21, 500 '17-23

LOCK & RIDE HALF WINDSHIELD - POLY

- Strong, durable polycarbonate half windshield delivers a combination of protection and airflow into the cab
- Half windshield offers protection from rain, sleet, spray, and off-road hazards

• 2883320 • \$199^{MS}
EV '15-23, CREW 570-4 '15-21, 570 '15-21, 500 '17-23

REAR PANELS



LOCK & RIDE FLIP-DOWN WINDSHIELD - HARD COAT POLY

- Two venting options: fully sealed or flip-down/ remove upper half for some protection with maximum ventilation

• 2882178 • \$589^{MS}
EV '15-23, CREW 570-4 '15-21, 570 '15-21, 500 '17-23

LOCK & RIDE VENTED WINDSHIELD - HARD COAT POLY

- Frameless design for maximum visibility
- Added vents for airflow on a hot day or defrosting on a cold day

• 2883342 • \$564^{MS}
EV '15-23, CREW 570-4 '15-21, 570 '15-21, 500 '17-23

LOCK & RIDE FULL WINDSHIELD - HARD COAT POLY

- Durable, optical-grade, .236"-thick polycarbonate offers outstanding rider protection and visibility
- Windshield has minimal perimeter framework for full visibility

• 2883319 • \$529^{MS}
EV '15-23, CREW 570-4 '15-21, 570 '15-21, 500 '17-23

LOCK & RIDE REAR PANEL - GLASS

- Durable, tempered laminate glass provides a high level of scratch resistance

• 2879965 • \$399^{MS}
EV '15-23, CREW 570-4 '15-21, 570 '15-21, 500 '17-23

LOCK & RIDE REAR PANEL - POLY

- Strong, .236"-thick polycarbonate provides outstanding impact and scratch resistance

• 2879812 • \$299^{MS}
EV '15-23, CREW 570-4 '15-21, 570 '15-21, 500 '17-23

HARD COAT POLY | 30x MORE SCRATCH-RESISTANT



REDUCE IN-CAB DUST SWIRL BY ADDING A REAR PANEL

With a windshield and roof installed, turbulent air develops behind the cab. Add a rear panel to reduce dust intrusion from this swirl.

CONVENIENCE & PROTECTION



CONVENIENCE FEATURES

CAB SEAL SYSTEM

- 2-SEAT • 2880508 • \$124 ^{MS}
EV '15-23, CREW 570-4 '15-21, 570 '15-21, 500 '17-23
(INCLUDED WITH PREMIUM DOORS)

EPS SYSTEM (ELECTRIC POWER STEERING)

- Enjoy smooth, easy, precise, responsive automotive-quality power steering
- EPS provides a light steering feel in all situations, including low-speed maneuvering through challenging terrain

- 2879970 • \$1,379 ^{MS}
CREW 570-4 '15-21, 570 '15-21
1824163 REQUIRED FOR 2015 AND NEWER 570 MODELS

HORN

- 2879273 • \$69 ^{MS}
EV '15-23, CREW 570-4 '15-21, 570 '15-21, 500 '17-23

AUXILIARY BATTERY KIT

- 2880555 • \$319 ^{MS}
EV '15-23
REQUIRED FOR 12V ACCESSORIES ON EV

REVERSE WARNING ALERT

- 2880631 • \$84 ^{MS}
CREW 570-4 '15-21, 570 '15-21, 500 '17-23

SPEEDKEY

- 2879988 • \$319 ^{MS}
CREW 570-4 '15-21, 570 '15-21

FIELD TESTED INTERIOR

ADD SUPERIOR ALL-WEATHER FUNCTIONALITY

and comfort to your RANGER with premium Polaris Engineered Accessories. Keep warm on the coldest of days with a heater kit and improve visibility with a Windshield Wiper and Washer System or Large Rear View Mirror.



WINDSHIELD WIPER & WASHER SYSTEM

- Use with Full Glass Windshield 2881783 only
- 2879968 • \$589 ^{MS}
EV '15-23, CREW 570-4 '15-21, 570 '15-21, 500 '17-23
⚠ Requires Battery Connection Cable



LARGE REAR VIEW MIRROR ^{TOP SELLER}

- 2879969 • \$74 ^{MS}
EV '15-23, CREW 570-4 '15-21, 570 '15-21, 500 '17-23

STANDARD BRUSHGUARDS

PERFECT FOR: **INCREASED PROTECTION AROUND LIGHTING AND FENDERS**



1 3/4" DIAMETER
STEEL TUBE CONSTRUCTION

- REAR • 2879972 • \$259 ^{MS}
EV '15-23, CREW 570-4 '15-21, 570 '15-21, 500 '17-23
DOES NOT WORK WITH FLIP-DOWN POLY WINDSHIELD 2881919

WINCHES

FEATURES	PRO PRO HEAVY DUTY SERIES	HD HEAVY DUTY SERIES	
RAPID ROPE RECOVERY	STANDARD	NOT AVAILABLE	<p>1 YR WARRANTY</p>
AUTO STOP TECHNOLOGY	STANDARD	OPTION	
WINCH LINE	SYNTHETIC ROPE	STEEL CABLE	
CONTROL	WIRELESS STANDARD, WIRED OPTION	WIRED STANDARD, WIRELESS OPTION	
MODEL	4,500 LB.	3,500 LB.	ADD REQUIRED CABLES
570 '15-21 CREW 570-4 '15-21 500 '17-23 EV '19-23 EV REQUIRES AUXILIARY BATTERY KIT 2880555	<p>2882238 \$874.99</p>	<p>2881669 \$484.99</p>	2-SEAT MODELS: ^{TOP SELLER} 2879990 \$49.99 CREW MODELS: 2880929 \$59.99

UPGRADE YOUR HD WINCH WITH THESE ACCESSORIES

WIRELESS REMOTE

- Up to 50 ft. range with LED indicator
- Direct plug and play operation
- 2879316 • \$139 ^{MS}
Works with 2881669

SYNTHETIC ROPE

- 4,500 LB.
2879187 • \$139 ^{MS}
- 3,500 LB.
2878888 • \$84 ^{MS}

AUTO STOP UPGRADE

- Billet aluminum
- Replaces stock fairlead
- 2881693 • \$109 ^{MS}
Works with 2881669
SYNTHETIC ROPE REQUIRED

UPGRADE YOUR CONTROLS HD OR PRO HD WINCHES

WIRED REMOTE CONTROL

- Must order remote handle and socket together
- REMOTE HANDLE
4013466 • \$68 ^{MS}
- SOCKET
4014228 • \$49 ^{MS}

POWER CONTROLLER

- Control your winch and plow hydraulics directly from the shift knob
- 2879227 • \$49 ^{MS}
CREW 570-4 '14-21, 570 FULL SIZE '17-23, 570 '14-21, 500 '15-23



STORAGE



LOCK & RIDE

Exclusive and available on all Polaris vehicles, Lock & Ride accessories let you quickly change from one task to another with hundreds of options.

WITH THE FLIP OF A LEVER, LOCK & RIDE PLUNGERS USE OUTWARD PRESSURE TO EXPAND FOR A SECURE FIT.



LOCK & RIDE CARGOMAX SYSTEM

- Comes standard with a support bar that ties the two sides together for a sturdy cargo hold
- Adjustable utility hooks provide more options for hanging tools, cords or gear
- Two sides and a support bar included

▶ 2882177 • \$564 **
EV '15-23, CREW 570-4 '15-21,
570 '15-21, 500 '17-23



LOCK & RIDE STORAGE BOX

- Rugged roto-molded construction locks for security and is water-resistant
- Low-profile design retains additional hauling capacity on top of vault
- Sliding drawer features foam padding and adjustable dividers
- Fits perfectly in the bed of your RANGER, pickup box or full-size SUV

▶ 2877033 • \$349 **
EV '11-23, CREW 570-4 '14-21, 570 '14-21, 500 '11-23



LOCK & RIDE TOOL RACK

- Attach on the inside or outside of the cargo bed
- ▶ 2881533 • \$259 **
EV '11-23, CREW 570-4 '14-21, CREW 570 FULL SIZE '18-23,
570 FULL SIZE '17-23, 570 '14-21, 500 '11-23



RIDE & REPAIR ESSENTIALS KIT

▶ 2881207 • \$109 **
EV '11-23, CREW 570-4 '14-21, CREW 570 FULL SIZE '18-23,
570 FULL SIZE '17-23, 570 '14-21, 500 '11-23

STRAPS



1.5' x 15' 5,500 LB. RATCHET STRAP

- Heavy-duty webbing
 - 2 Pack
- ▶ 2884031 • \$44 **



FIRE EXTINGUISHER HOLDER

- Quick-release strap allows for easy access
- ▶ 2882158 • \$89 **
EV '15-23, CREW 570-4 '15-21, 570 '15-21, 500 '17-23



LOCK & RIDE D-RINGS

- The most versatile Lock & Ride accessory - add as many as you need to secure your cargo with bungee cords or straps
- ▶ 2881545 • \$34 **
EV '11-23, CREW 570-4 '14-21, CREW 570 FULL SIZE '18-23,
570 FULL SIZE '17-23, 570 '14-21, 500 '11-23



UNDER SEAT STORAGE BOX

▶ 2880046 • \$109 **
EV '15-23, CREW 570-4 '15-21, 570 '15-21, 500 '17-23



LOCK & RIDE CHAINSAW MOUNT

▶ 2879354 • \$139 **
EV '11-23, CREW 570-4 '14-21, CREW 570 FULL SIZE '18-23,
570 FULL SIZE '17-23, 570 '14-21, 500 '11-23



LOCK & RIDE QUICKSTRAP

- The quickest and most secure way to mount Polaris accessories
 - Sold as a pair
- ▶ 2882187 • \$44 **
ALL COOLERS, RANGER CARGO BOXES



2' x 20' 10,000 LB. RATCHET STRAP

- Heavy-duty webbing
- ▶ 2884032 • \$34 **

DO MORE:



COOLERS
P. 46



HUNT
P. 48

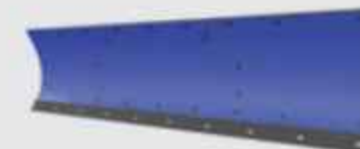

COLD WEATHER
P. 50



LIGHTING
P. 56

PERFORMANCE & COMFORT

THE RANGER 570 FULL-SIZE builds on its legendary reputation for getting the job done. With the industry's most complete lineup of Polaris Engineered Accessories, it's ready for anything your work demands.



DO MORE:



COOLERS
P. 46



COLD WEATHER
P. 50



HUNT
P. 48



LIGHTING
P. 56

ROOFS



SPORT ROOF

- Lightweight, rugged polyethylene construction
- Offers protection from sun and rain
- Does not work with Full Doors
- ▶ **TOP ROLLER** 3-SEAT • 2877946 • **\$439** ^{MS}
570 FULL SIZE '17-21
- ▶ **CREW** • 2878755 • **\$699** ^{MS}
CREW 570 FULL SIZE '17-23



BIMINI SOFT TOP

- Tight-fitting canvas soft top with easy on/off design
- Lightweight 600 denier, solution-dyed polyester construction
- ▶ 2876963-067 • **\$109** ^{MS}
570 FULL SIZE '17-23

ROOF/REAR PANEL



CANVAS ROOF/REAR PANEL

- Constructed from premium, mold-resistant polyester with UV stabilizers
- Durable, heat-sealed vinyl window for crack resistance
- ▶ 2883471 • **\$409** ^{MS}
570 FULL SIZE '17-23

DOORS



RANGER CANVAS DOORS

- Constructed from premium, mold-resistant polyester with UV stabilizers
- Durable, heat-sealed vinyl window for crack resistance
- Zip-down windows for adjustable ventilation
- ▶ 2876962-067 • **\$994** ^{MS}
570 FULL SIZE '17-23
REQUIRES 2883471 CANVAS ROOF/REAR PANEL
DOES NOT FIT WITH 2877946 OR 2876963-067.

PROTECTION



BRUSHGUARDS

- Provides front impact resistance and headlight protection
- Durable, scratch-resistant black powder-coated finish
- Can be used with accessory winch or plow system
- Does not interfere with rear cargo drop gate
- ▶ **FRONT** • 2881662 • **\$234** ^{MS}
CREW 570 FULL SIZE '18-23, 570 FULL SIZE '17-23
- ▶ **REAR** • 2881661 • **\$184** ^{MS}



HORN

- ▶ 2875048 • **\$79** ^{MS}
570 FULL SIZE '17-23

REVERSE BEEPER

- ▶ 2880631 • **\$84** ^{MS}
CREW 570-4 '15-21, 570 '15-21, 500 '17-23

WINDSHIELDS



POLY WINDSHIELD

- Optical-grade, .236"-thick polycarbonate for outstanding protection and visibility
- ▶ **HARD COAT** • 2879489 • **\$534** ^{MS}
CREW 570 FULL SIZE '18-23, 570 FULL SIZE '17-23
- ▶ **TOP ROLLER** GENERAL PURPOSE • 2876958 • **\$434** ^{MS}
CREW 570 FULL SIZE '18-23, 570 FULL SIZE '17-23



LOCK & RIDE HALF WINDSHIELD

- Durable, optical-grade, .177"-thick polycarbonate for impact-resistance
- Half-height design delivers improved airflow for hot/dusty conditions
- Retains sporty, rugged look
- ▶ 2878756 • **\$229** ^{MS}
CREW 570 FULL SIZE '18-23, 570 FULL SIZE '17-23

REAR PANEL



POLY REAR PANEL

- Constructed from thick, impact resistant polycarbonate
- Delivers protection from the elements and a quieter ride
- Scratch-resistant for years of clear vision
- Contoured design eliminates perimeter framework for full rearward visibility
- ▶ 2878165 • **\$299** ^{MS}
CREW 570 FULL SIZE '18-23, 570 FULL SIZE '17-23

WINCHES

FEATURES	PRO PRO HEAVY DUTY SERIES	HD HEAVY DUTY SERIES	WARRANTY 1 YR
RAPID ROPE RECOVERY	STANDARD	NOT AVAILABLE	
AUTO STOP TECHNOLOGY	STANDARD	OPTION	
WINCH LINE	SYNTHETIC ROPE	STEEL CABLE	
CONTROL	WIRELESS STANDARD, WIRED OPTION	WIRED STANDARD, WIRELESS OPTION	
MODEL	4,500 LB.	3,500 LB.	
570 FULL-SIZE '16-23 CREW 570 FULL-SIZE '16-23	2882238 \$974.99	2881669 \$484.99	ADD REQUIRED CABLES 3-SEAT MODELS: 2881684 \$34.99 CREW MODELS: 2880929 \$59.99

UPGRADE YOUR HD WINCH WITH THESE ACCESSORIES

- WIRELESS REMOTE**
 - Up to 50 ft. range with LED indicator
 - Direct plug and play operation
 - ▶ 2879316 • **\$139** ^{MS}
WORKS WITH 2881669

- SYNTHETIC ROPE**
 - 3,500 LB.
 - ▶ 2878888 • **\$84** ^{MS}
 - 4,500 LB.
 - ▶ 2879187 • **\$139** ^{MS}
- STEEL CABLE**
 - 3,500 LB.
 - ▶ 2878890 • **\$44** ^{MS}

- AUTO STOP UPGRADE**
 - Billeted aluminum
 - Replaces stock fairlead
 - ▶ 2881693 • **\$109** ^{MS}
WORKS WITH 2881669
SYNTHETIC ROPE REQUIRED

UPGRADE YOUR CONTROLS HD OR PRO HD WINCHES

- WIRED REMOTE CONTROL**
 - Must order remote handle and socket together
 - ▶ **REMOTE HANDLE** 4013466 • **\$68** ^{MS}
 - ▶ **SOCKET** 4014228 • **\$49** ^{MS}

- POWER CONTROLLER**
 - Control your winch and plow hydraulics directly from the shift knob
 - ▶ 2879227 • **\$49** ^{MS}
EV '11-23, CREW 570-4 '14-21, 570 FULL SIZE '17-23, 570 '14-21, 500 '11-23

LOCK & RIDE ADD STORAGE TO YOUR RANGER 570 P. 76

HIT THE TRAILS RANGER 150 EFI ACCESSORIES



YOUTH CRAWLER TIRE

- Premium durability to ride longer
- Increased ground clearance and performance

150 EFI '18-23

	TREAD DEPTH	TIRE WEIGHT	PLY RATING	SIDEWALL BELTS	LOAD RATING	
22" • 8" R12 5410895 • *109 ^{MS}	FRONT/REAR	13 mm	18 lbs	6	3	910 lbs
22" • 10" R12 5416991 • *111 ^{MS}						



YOUTH BUCKLE WHEEL

- FRONT • 12" • 7" • 1524114 • *94^{MS}
- REAR • 12" • 8" • 1524115 • *104^{MS}

150 EFI '18-23



PRO ARMOR WHEEL & TIRE KIT: YOUTH CRAWLER & BUCKLE

- 2885154 • *764^{MS}

150 EFI '18-23



FULL-WINDSHIELD - POLY

- .125" clear poly carbonate
- Mounts with four simple P-clamps

- 2883288 • *164^{MS}

150 EFI '18-23



HALF-WINDSHIELD - POLY

- 13" tall
- .125" clear poly carbonate
- Mounts with four simple P-clamps

- 2883298 • *109^{MS}

150 EFI '18-23



FRONT & REAR BRUSHGUARD SET

- Durable, e-coated steel construction
- Front and rear brushguard included

- 2883287 • *109^{MS}

150 EFI '18-23



SPORT ROOF - POLY

- Stay protected from rain, snow and sun
- Easily installs

- 2883289 • *214^{MS}

150 EFI '18-23

FOR THE LIFE OF YOUR RIDE

PARTS THAT PUSH THE LIMITS WITHOUT SACRIFICING STRENGTH AND DURABILITY.
We build our products so anyone with the right tools can maintain their vehicle.

POLARIS
ENGINEERED PARTS & LUBRICANTS

PARTS & GARAGE

MAINTENANCE

OIL LUBRICANTS

MAINTENANCE FLUIDS

GARAGE ACCESSORIES BATTERY CHARGERS

HO PARTS

SERVICE PARTS

RESALE/ANT B TRAILERING

POLARIS POWER

RESALE/ANT B TRAILERING

POLARIS POWER

93

MAINTENANCE TIP

BREAK-IN PERIOD

The break-in period for your new RANGER is the first 25 hours of operation, or the time it takes to use the first two tanks of fuel. No single action on your part is as important as a proper break-in period. Careful treatment of a new engine will result in more efficient performance and longer life for the engine.

NOTICE: Excessive heat build-up during the first three hours of operation will damage close-fitted engine parts. Do not operate at full throttle or high speeds for extended periods during the first three hours of use.

SEE OUR LATEST MAINTENANCE TIPS AT RANGER.POLARIS.COM/EN-US/SELF-HELP

AIR FILTER

A clogged air filter can restrict air flow to the engine leading to reduced engine performance, engine life or catastrophic failure.

BRAKE PADS

Maintaining and/or replacing brakes are critical to the safety and functionality of a vehicle. Brake pads should be checked for wear and oil or grease (petroleum products) contamination and brake discs should be checked for cracks, excessive corrosion or warping.

HALF SHAFT

Check for tears and punctures in the boot, which can lead to CV joint wear that can contribute to axle failure.

BATTERY

To ensure a battery maintains its level of charge when unused for extended periods of time or during freezing weather, the battery should be connected to a NOCO® Battery Charger (see P. 99). Be sure to check for corrosion from the terminals to the ends of the cables.

DRIVE BELT

Polaris Engineered belts deliver unmatched performance for your off-road vehicle. Developed and tested on all our engines for all environments and conditions. Check your belt for delamination, hour glassing and glazing.

BREAK-IN PERIOD

- Use lower gear (if available) while varying speeds and avoid wide open throttle for 5-10 miles / 8-16 km
- If no low gear is available, vary at moderate speeds while avoiding wide open throttle for 50 miles / 80 km

OUR INVESTMENT

- 40,000+ miles / 64,00+ km of field testing
- Thousands of dyno hours
- 18+ months of development (13,000+ design hours) per belt
- 1,500+ vehicle validation hours
- Collaboration with powertrain and clutch engineers

YOUR ADVANTAGE

- No clutch recalibration
- Less wear and tear due to heat
- Ensure maximum vehicle performance
- More time riding, less time wrenching
- Produced in collaboration with powertrain and clutch engineers to ensure a perfect fit, maximum performance and ultimate durability

OIL FILTER

Change oil filters with every oil change to provide the best engine protection and keep the engine operating at peak performance.

FOLLOW RECOMMENDED SERVICE INTERVALS IN THE OWNER'S MANUAL

MAINTENANCE SCHEDULE

25 HRS / 250 MI / 400 km

BREAK-IN MAINTENANCE

- ENGINE OIL & OIL FILTER:** CHANGE
- GENERAL LUBRICATION:** ALL FITTINGS, PIVOTS, CABLES, ETC.
- AIR FILTER:** INSPECT & REPLACE AS NEEDED
- EXHAUST SYSTEM:** INSPECT & CLEAN
INSPECT FOR LEAKAGE OR CARBON BUILD UP AT JOINTS
INSPECT & CLEAN SCREEN TYPE SPARK ARRESTOR

50 HRS / 500 MI / 800 km

6 MONTHS

- EXHAUST SYSTEM:** INSPECT & CLEAN
INSPECT FOR LEAKAGE OR CARBON BUILD UP AT JOINTS
- INSPECT & CLEAN SCREEN TYPE SPARK ARRESTOR
- GENERAL LUBRICATION:** ALL FITTINGS, PIVOTS, CABLES, ETC.

100 HRS / 1,000 MI / 1,600 km

12 MONTHS

- ENGINE OIL & OIL FILTER:** CHANGE
- DRIVE BELT:** INSPECT & ADJUST
REPLACE AS NEEDED
- TRANSMISSION FLUID:** CHANGE
- FRONT DRIVE FLUID:** CHANGE
- DRIVE BELT:** INSPECT & ADJUST
REPLACE AS NEEDED
- EXHAUST SYSTEM:** INSPECT & CLEAN
INSPECT FOR LEAKAGE OR CARBON BUILD UP AT JOINTS
INSPECT & CLEAN SCREEN TYPE SPARK ARRESTOR

150 HRS / 1,500 MI / 2,400 km

18 MONTHS

- ENGINE OIL & OIL FILTER:** CHANGE
- BATTERY:** TEST, CLEAN & REPLACE AS NEEDED
- DRIVE BELT:** INSPECT & ADJUST
REPLACE AS NEEDED
- TIRES:** INSPECT CONDITION & PRESSURE
- EXHAUST SYSTEM:** INSPECT & CLEAN
INSPECT FOR LEAKAGE OR CARBON BUILD UP AT JOINTS
INSPECT & CLEAN SCREEN TYPE SPARK ARRESTOR

200 HRS / 2,000 MI / 3,200 km

24 MONTHS

- ENGINE OIL & OIL FILTER:** CHANGE
- BRAKE PADS & FLUID:** INSPECT & CLEAN
REPLACE AS NEEDED
- SPARK PLUGS:** INSPECT
REPLACE AS NEEDED
- EXHAUST SYSTEM:** INSPECT & CLEAN
INSPECT FOR LEAKAGE OR CARBON BUILD UP AT JOINTS
INSPECT & CLEAN SCREEN TYPE SPARK ARRESTOR

250 HRS / 2,500 MI / 4,023 km

30 MONTHS

- ENGINE OIL & OIL FILTER:** CHANGE
- BATTERY:** TEST, CLEAN & CHECK FLUID LEVEL
REPLACE AS NEEDED
- DRIVE BELT:** INSPECT & ADJUST
REPLACE AS NEEDED
- GENERAL LUBRICATION:** ALL FITTINGS, PIVOTS, CABLES, ETC.
- EXHAUST SYSTEM:** INSPECT & CLEAN
INSPECT FOR LEAKAGE OR CARBON BUILD UP AT JOINTS
INSPECT & CLEAN SCREEN TYPE SPARK ARRESTOR

300 HRS / 3,000 MI / 4,826 km

36 MONTHS

- ENGINE OIL & OIL FILTER:** CHANGE
- AIR FILTER:** INSPECT & REPLACE AS NEEDED
- GEARCASES:** CHECK OIL LEVEL
- EXHAUST SYSTEM:** INSPECT & CLEAN
INSPECT FOR LEAKAGE OR CARBON BUILD UP AT JOINTS
INSPECT & CLEAN SCREEN TYPE SPARK ARRESTOR

CHECK YOUR OWNER'S MANUAL FOR ADDITIONAL RECOMMENDED SERVICE ITEMS AND VEHICLE-SPECIFIC TIMING

OIL

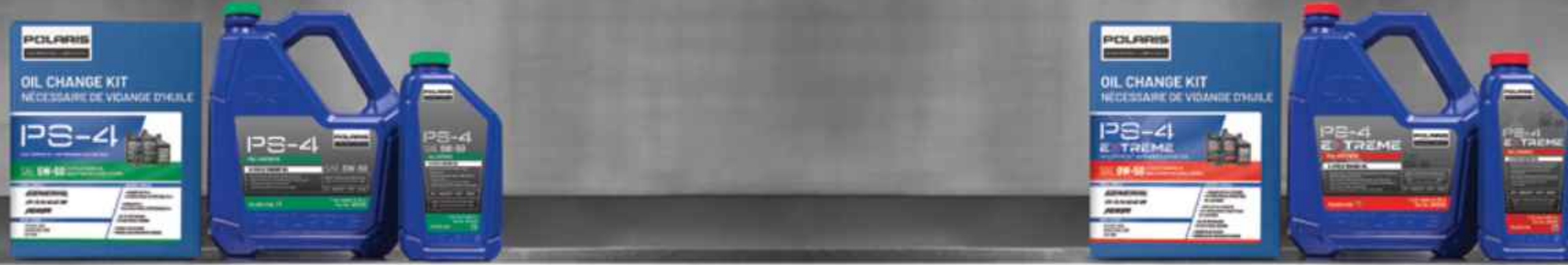

PS-4 FORMULATIONS BEST PROTECTION, BEST PERFORMANCE

Our new PS-4 5W-50 formulation and PS-4 Extreme Synthetic 0W-50 have been designed to provide the best fluid technologies for long lasting wear protection. These formulations include a new Polaris exclusive additive system to keep the engine cleaner from deposit build-up to maximize power and powersports-grade synthetic base stocks that provide the ultimate in engine protection.

PS-4 5W-50 FULL-SYNTHETIC OIL

Optimal for ambient operating temperatures of -40° F to 100° F

• 1 Quart 2876244 • 1 Gallon 2876245 • 16 Gallons 2876247 • 55 Gallon Drum 2876246 • 330 Gallon Tote 2878814

PS-4 0W-50 EXTREME FULL-SYNTHETIC OIL

Optimal for ambient operating temperatures of -45° F to 130° F

• 1 Quart 2889395 • 1 Gallon 2889396 • 16 Gallons 2889397 • 55 Gallon Drum 2889398 • 330 Gallon Tote 2889399

PS-4 5W-50	OIL CHANGE KITS	PS-4 EXTREME 0W-50
PART NUMBER	VEHICLE FITMENT	PART NUMBER
2202166	RANGER/RZR/SPORTSMAN 570, TWIN 600, TWIN 700, TWIN 800	2890056
2879323	RANGER, POLARIS GENERAL 900-1000, RZR 900-1000, RS1	2890057
2877473	RANGER/SPORTSMAN 300-500, SPORTSMAN/SCRAMBLER 500/850/1000	2890055
2881696	RZR TURBO	2890058

ENGINE WEAR TEST LOWER NUMBER = LESS WEAR OF CRITICAL ENGINE PARTS LESS WEAR MEANS LONGER ENGINE LIFE

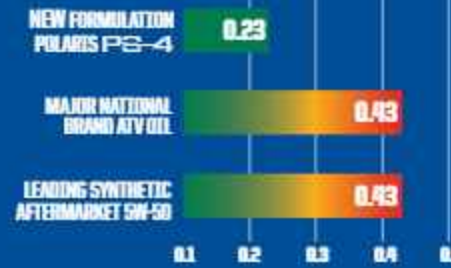

ASTM D9922. In 3rd party against 11 competitor products Polaris had 40% or better wear protection compared to all of the test products.

THE BEST PROTECTION

• At least 40% improved wear protection compared to previous Polaris PS-4 formulation and all aftermarket oils tested

Best engine protection against wear for the longest engine life.

DEPOSIT TEST LOWER DEPOSITS = MAXIMUM POWER

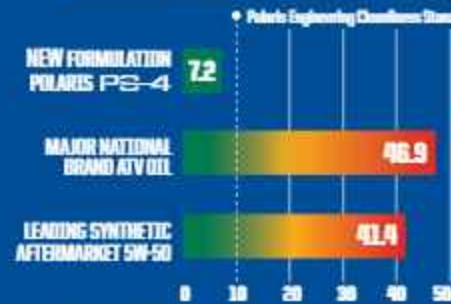

ASTM D8825. In 3rd party against 11 competitor products Polaris PS-4 had less than half the deposits compared to the next cleanest product. No other tested products met Polaris Engineering standards for deposit cleanliness.

MAXIMUM PERFORMANCE

• New Improved PS-4 formulation provides 33% less deposits than previous PS-4 formula

• At least 50% less deposits than all aftermarket oils tested

The cleanest engine for maximum power and performance!

POLARIS EXTREME SYNTHETICS

Our new PS-4 Extreme Synthetic 0W-50 formulation applies only to the **absolute highest performance** products we sell, for ultimate protection and performance in the most extreme conditions.



• Our best extreme high temp formulation, excellent for severe high temperatures and for racing, even at temps over 130°F.

• Provides easier starting and cold temperature protection, even to extreme cold temps of below -45°F.

• Latest in premium synthetic PAO and Ester base stocks along with careful balance of moly and ZDDP additives for ultimate long lasting wear protection.

• Polaris exclusive clean engine additive system reduces deposits and carbon build-up for peak performance and power.



POLARIS INVESTS IN EACH OIL AT AND ABOVE THESE LEVELS

12+ DEDICATED
TEAM MEMBERS

FOCUSED ON
POLARIS OIL

18+
MONTHS

DEVELOPMENT
& TESTING

76,000+
HOURS

DYNO
TESTING

2.2/3.5 MILLION+
MILES/KM

FIELD
TESTING

MAINTENANCE FLUIDS



ENGINE OIL

Maximum protection for your 4-cycle engine.
NOT COMPATIBLE WITH XP KINETIC



AGL

Protect gears, drive chain and bearings from scoring and wear.

- ▶ 1 QT • 2878068
- ▶ 1 GALLON • 2878069
- ▶ 2.5 GALLONS • 2878070
- ▶ 55 GALLONS • 2879594

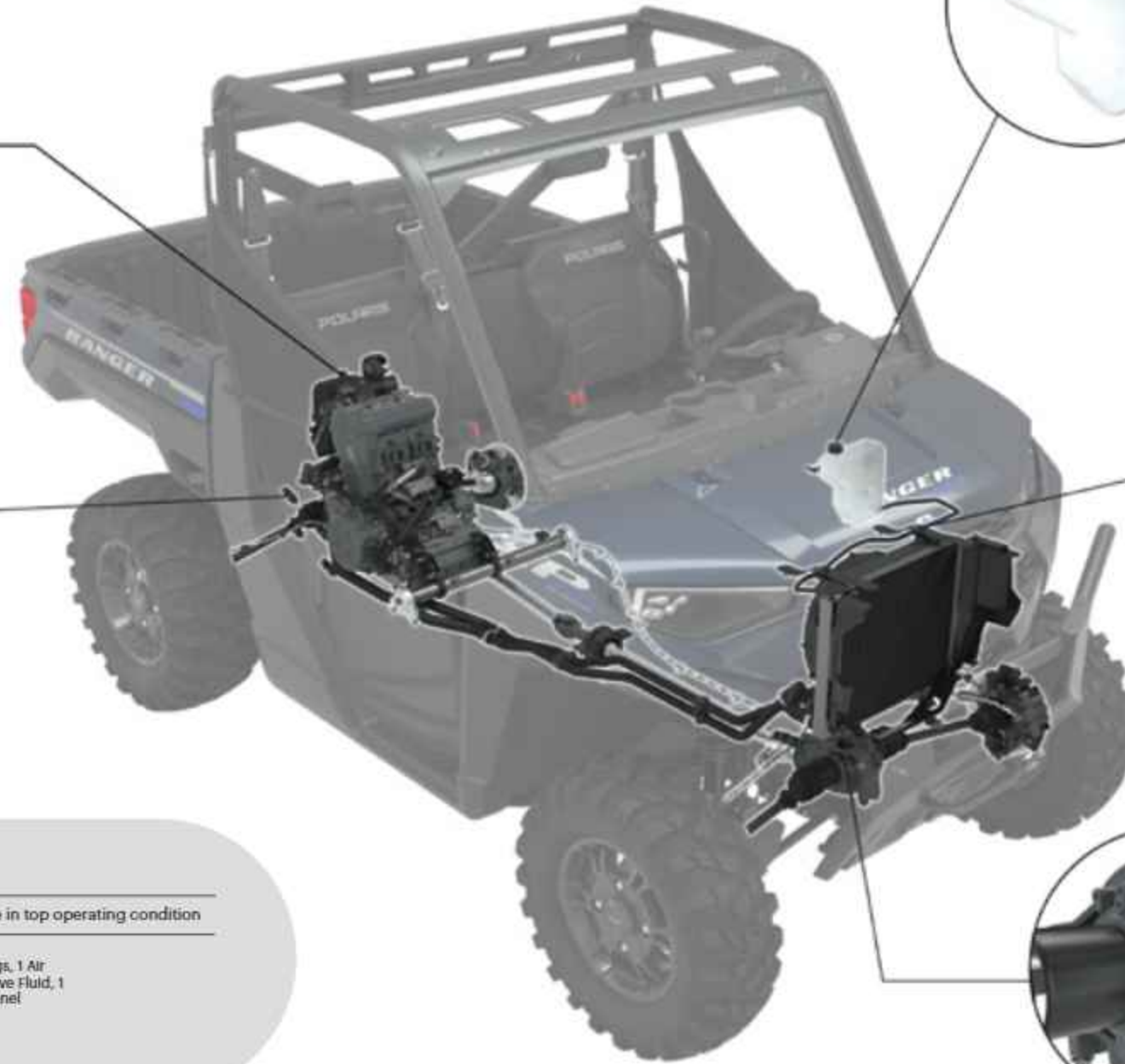

ANTI-FREEZE

Prevent corrosion on metal components, eliminate scaling and maximize cooling system performance.

- ▶ 1 QT • 2880514
- ▶ 1 GALLON • 2880513
- ▶ 55 GALLONS • 2880512



DOT 4 BRAKE FLUID

A high-quality brake fluid designed for use in Polaris hydraulic brakes.

- ▶ 12 OZ • 2872189



DEMAND DRIVE FLUID

Provide positive 4WD engagement in extreme cold or high heat conditions and protect internal components under heavy loads.

- ▶ 1 QT • 2877922
- ▶ 2.5 GALLONS • 2877923



ORV MAINTENANCE KITS

Everything you need, in the correct fluid volumes, to maintain your drive train and keep your vehicle in top operating condition

Includes: 2.5 quarts of PS-4, 2 Spark Plugs, 1 Air Filter, 2 quarts of AGL, 1 pint Demand Drive Fluid, 1 oil filter, 1 crush washer & 1 Paper Oil Funnel

- ▶ 2830555
XP 900 '13-15



Includes: 2.5 quarts of PS-4, 2 Spark Plugs, 1 Air Filter, 2 quarts of AGL, 1 pint Demand Drive Fluid, 1 oil filter, 1 crush washer & 1 Paper Oil Funnel

- ▶ 2830556
XP 1000 '18-23



PREMIUM GAS SHOCK OIL

- ▶ 1 QT • 2874124
WALKER EVANS RACING® REBUILDABLE SHOCKS
- ▶ 1 QT PREMIUM • 2870995
- ▶ 2.5 GALLONS PREMIUM • 2872279
FOX® REBUILDABLE SHOCKS
NOT COMPATIBLE WITH XP KINETIC



SUSPENSION/ U-JOINT GREASE

- ▶ 3 OZ • 2871515
- ▶ 14 OZ • 2871551



CHAIN LUBRICANT

Provides superior anti-wear and shock protection

- ▶ 16 OZ AEROSOL 2872348
NOT COMPATIBLE WITH XP KINETIC



ALL-SEASON GREASE TUBE

Specialized water resistant lubricant

- ▶ 3 OZ • 2871322
- ▶ 14 OZ • 2871423



ANGLE DRIVE FLUID

Extreme pressure, anti wear and high viscosity film lubrication for maximum protection

- ▶ 1 QT • 2889280
RANGER ANGLE DRIVE GEAR CASE SYSTEMS. NOT COMPATIBLE WITH XP KINETIC



GENERATOR OIL

4-cycle engine oil

- ▶ 1 QT • 2879383



CARBON CLEAN

Ultimate fuel and injection system cleaner

- ▶ 12 OZ • 2881413
NOT COMPATIBLE WITH XP KINETIC



ADVANCED FUEL TREATMENT

Dual antioxidant formula protects jets and fuel system from gum and varnish

- ▶ 12 OZ • 2881416
NOT COMPATIBLE WITH XP KINETIC

GARAGE ACCESSORIES



PREMIUM MAINTENANCE TOOL KIT

- Includes everything you need to work on and repair Polaris vehicles
- Lifetime warranty on select tools

▶ 2830565 • \$499⁹⁹



FLUID FUNNEL

- Easily add oil with high accuracy

▶ 2830552 • \$12⁹⁹



NEW FUNNELS

- Unique capped design eliminates spills and contaminants

▶ BLUE • 2830574 • \$8⁹⁹
 ▶ RED • 2830575 • \$8⁹⁹
 ▶ GREEN • 2830576 • \$8⁹⁹



NEW HANDHELD PUMP SPRAYER

- Half gallon portable sprayer, lightweight and easy to use

▶ 2830570 • \$12⁹⁹



NEW GREASE GUN

- Comfort grip handle and heavy-duty follower spring for high pressure applications and easy priming

▶ 14 OZ • 2830569 • \$34⁹⁹
 FOR 14 OZ ALL-SEASON & U-JOINT



GREASE GUN

- Enables easy application of grease

▶ 3 OZ • 2871312 • \$39⁹⁹
 FOR 3 OZ ALL-SEASON & U-JOINT



FLEX SPOUT

- Fits all Polaris quart, gallon and 2.5 gallon bottles

▶ 2871285 • \$3⁹⁹



PUMP

- Fits 1 and 2.5 gallon bottles

▶ 2870465 • \$7⁹⁹



FLUID SYRINGE

- Easily add and remove fluid from your vehicle

▶ 2830553 • \$29⁹⁹



2D BATTERY-OPERATED SIPHON PUMP

- Liquid transfer pumps 5-6 quarts/min suctioning power

▶ 2830513 • \$16⁹⁹



NEW FLEXIBLE CLUTCH COVER TOOL

- The perfect tool for hard to reach CVT cover bolts

▶ 2830572 • \$14⁹⁹



OIL FILTER WRENCH

- Remove Polaris ORV oil filters with ease

▶ 2830550 • \$7⁹⁹



FLUID TRAY

- Holds up to 8 quarts of fluid

▶ 2830551 • \$19⁹⁹



POLARIS MAGNETIC PARTS TRAY

- ▶ SILVER • 2830432 • \$12⁹⁹



POLARIS 33" TELESCOPIC MAGNET

▶ BLACK • 2830435 • \$4⁹⁹



POLARIS 12" HI-TORQUE RATCHETING DRIVER

▶ BLACK / BLUE • 2830434 • \$19⁹⁹



POLARIS LED POCKET FLASHLIGHT

▶ BLACK • 2830436 • \$24⁹⁹

BATTERY CHARGERS



NOCO® BATTERY CHARGER - 1 AMP

- Ensure your battery is charged with the NOCO® Battery Charger 1 Amp
- Includes Boost Eyelet Cable with X-Connector Adapter (2830546)

▶ 2830567 • \$64⁹⁹



NOCO® BATTERY CHARGER - 2 AMP

- Ensure your battery is charged with the NOCO® Battery Charger 2 Amp
- Includes Boost Eyelet Cable with X-Connector Adapter (2830546)

▶ 2830568 • \$99⁹⁹



1,000 AMP ULTRASAFE LITHIUM JUMP PACK

- Delivers 1,000 amps for jump starting a dead battery in seconds

▶ 2830547 • \$124⁹⁹



JUMP PACK PROTECTION CASE

- Lightweight, durable and rugged custom exterior

▶ 2830548 • \$18⁹⁹

HD HEAVY DUTY PARTS

All Polaris parts are developed and tested to help you get the most out of your ride. We're taking the passion of our riders, workers and outdoor enthusiasts to the next level with HD Parts.

Engineered and designed for:

- Greater durability
- Enhanced performance
- Greater wear and tear capabilities
- All weather conditions

DRIVE BELTS

The enhanced rubber material compound in these belts keep them cool in extreme heat, while our patented cord treatment process maximizes the transfer of horsepower to the ground for those customers hauling heavy loads.

OE	HD
3211149	
3211169	3212326
3211196	
3211113	3212328



BUSHINGS

The advanced material compound of the bushings enables tighter tolerances to reduce overall wear on the system, while the superior triple lip sealing prevents intrusion of the elements.

LOCATION	OE	HD
FRONT UPPER BUSHINGS	5439874	1543367
	5439730	
	5439270	1543326
FRONT LOWER BUSHINGS	5439874	1543367
	5439730	
	5439270	1543326
REAR UPPER BUSHINGS	5439874	1543367
	5439730	
	5439270	1543326

LOCATION	OE	HD
REAR LOWER BUSHINGS	5439874	1543367
	5439730	
	5439270	1543326
UPPER HUB BUSHINGS	5439270	1543326
	5439270	1543326
LOWER HUB BUSHINGS	5439270	1543326
	5439270	1543326

OIL FILTERS

The advanced synthetic material built into these filters offers the highest debris holding capacity, maintains oil flow and maximizes performance.

OE	HD
2540066	2522485



WHEEL BEARINGS

Fully sealed for added protection against intrusions. Made of a higher grade steel for extended life in extreme conditions.

LOCATION	OE	HD
FRONT WHEEL BEARINGS	3514924	3515090
	3514634	3515088
REAR WHEEL BEARINGS	3514924	3515090
	3514917	3515087
	3514635	3515087



NEW BATTERY*

AGM fully sealed for optimal starting power with maximum reserve capacity, designed for highly accessorized vehicles and extreme operating conditions.

OE	HD
4014132	4081481



WHEELS & TIRES

Class leading durability for off-road performance and traction for confident driving in extreme conditions.

- 1524022-458 • HD WHEEL - 14x7"
- 5417507 • PRO ARMOR HD-K - 29x10R14*
- 5457498-458 • HD WHEEL CENTER CAP*
- 5415756 • PRO ARMOR XD-K FRONT
- 5415757 • PRO ARMOR XD-K REAR

* SHOWN



BUSHING KITS

Easily update the entire front and rear suspension.

- 2830560
XP 900 '13-'15, XP 900 CREW '14-'15, XP 1000 '17, XP 1000 CREW '17, S70 FULL SIZE '15-'20, S70 FULL SIZE CREW '15-'20
- 2830561 (shown)
S70 EFI '14-'20, S70 EFI CREW '14-'20



NEW DRIVE SHAFTS*

Designed for all around heavy-duty applications, the complete axle shaft assembly provides enhanced joint strength and includes TPE inner and outer boots which provide maximum puncture and tear resistance.

LOCATION	OE	HD
FRONT	1334351	1337241
	1332637	1337242
	1336966	1337243
REAR	1333748	1337239
	1334361	1337240



BRAKE PADS

Engineered to provide longer life and better stopping power while riding in extreme conditions.

OE	HD
2205949	2208933
2202413	2208934
2203318	2208936



NEW CV BOOT KIT

TPE rubber compound for maximum puncture and tear resistance, includes (1) boot, grease and clamp to replace OE stock part. Provides increased durability for riding in extreme conditions.

OE	HD
2204102	2209922
3236165	2209923



SAND



MUD



WATER



EXTREME COLD



EXTREME HEAT UP TO 130° F



HEAVY PAYLOADS



EXTENDED LIFE

PARTS & GARAGE

MAINTENANCE

OIL FLUIDS

MAINTENANCE FLUIDS

GARAGE ACCESSORIES & BATTERY CHARGERS

HD PARTS

SERVICE PARTS

RESILIENT & TRAILERING

POLARIS POWER

Claims made based off testing and performance of Polaris HD Parts against standard OEM parts made by Polaris and competitor brands under normal use.

*Check with your local dealer for availability.

For more information regarding Polaris HD parts including vehicle compatibility, installation and maintenance, please contact your authorized Polaris ORV dealer.

VISIT POLARIS.COM/SHOPRANGER TO LEARN MORE

SERVICE PARTS

Polaris Engineered service parts deliver unmatched performance and fit for your off-road vehicle.

All service parts are engineered specifically for your machine. Which means everything is designed, tested and perfected to maximize the life of your ride. Getting Polaris Engineered parts is a decision that pays off in the long run, because it ensures there is a long run.



**SHOP FOR SERVICE PARTS ONLINE
OR VISIT YOUR POLARIS DEALER.**

**OVER
100,000
PARTS
AVAILABLE!**



**CHECK OUT OUR PARTS FINDER ON POLARIS.COM
FOR EASY PARTS LOOK-UP, PARTS IDENTIFICATION, VIEWS OF ASSEMBLIES & MORE!**



STEP 1

Visit Polaris.com/RANGER
Click the "Accessories & Parts" tab
Click "Parts & Maintenance"



STEP 2

Enter **vehicle year/model** or
shop by **part number**



STEP 3

Clearly see what parts are
required and **order**

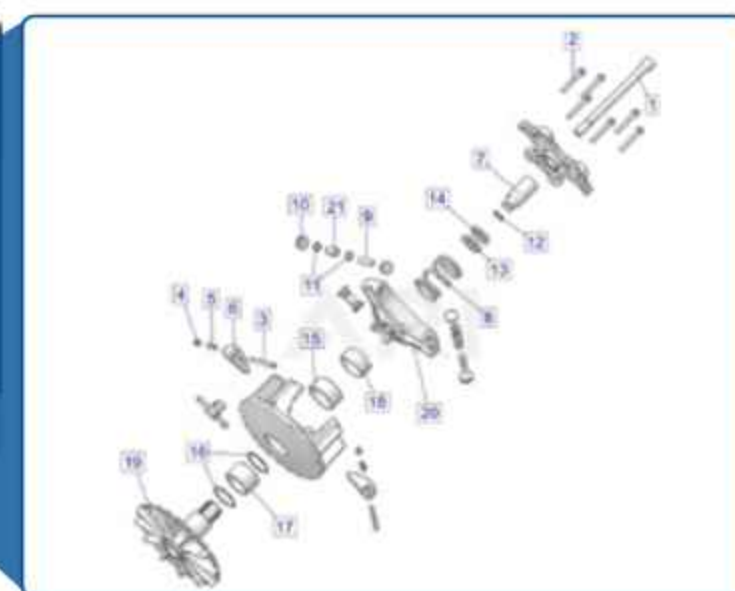

CV BOOT REPAIR KIT*

- A quick trail-side fix to increase trail time
- The flexible and durable boot material expands over a cone tool for CV boot repairs, without disassembling CV axles
- Universal fit - works as a temporary fix for most powersports axles
- All components fit inside the cone, and a cover is provided for compact durable storage
- Easily fits in a cargo box, attached to the roll cage, in the glovebox or many other storage locations.



Items shown are contained inside cone

FIX ON THE GO | TEMPORARY COVERAGE

UTV CV BOOT REPAIR KIT

Kit Includes the following items:

- (1) Expandable XL CV Boot
- (1) Reusable Cone Tool
- (2) CV Boot Clamps
- (1) Tube of Silicone Lube
- (1) Grease Packet
- (1) Cone Cover

▶ 2830526 • \$29 **

UTV TRAIL BOOT ONLY

▶ 2830527 • \$14 **

ATV

- CV REPAIR KIT 2830528 • \$25 **
- TRAIL BOOT ONLY 2830529 • \$14 **

SEE HOW THE CV BOOT REPAIR KIT WORKS AT POLARIS.COM/MAINTENANCE-VIDEOS

HOW TO INSTALL

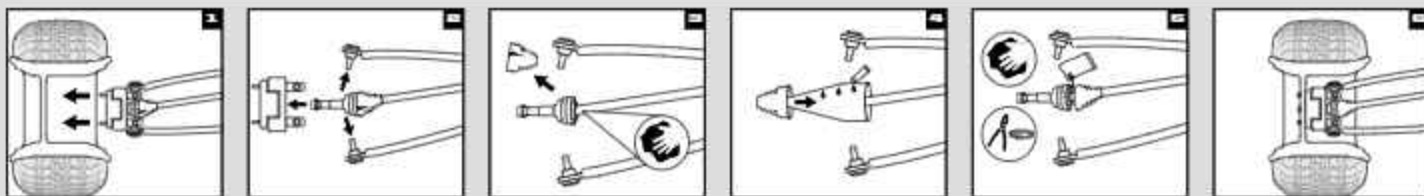

- Remove wheel and axle nut.
- Remove brake caliper, hub, tie rod and upper and lower ball joints.
- Remove old boot and clean joint.
- Spread silicone lube on entire cone tool. Slide boot over cone tool, large end first. See package for outer boot instructions.
- Empty the bag of grease into the CV joint/boot, clean sealing points and install clamps.
- Reassemble tie rod, ball joints, brake caliper, axle nut, tire and wheel.

Refer to your service manual for further instructions and torque specifications.
*Designed for temporary CV boot repair. Purchase the OEM CV Boot for a permanent repair.

TIRE SEALANT

HOW IT WORKS

Tire sealant remains liquefied inside the tire until a leak develops in the tire or wheel.



Once a leak occurs, the tire sealant rushes out of the tire and quickly creates a permanent solid plug.

The plug maintains the pressure of the tire so you can continue your ride.



PREMIUM TIRE SEALANT

- Instantly seals and repairs rim, bead leaks and punctures up to .25" on standard tires and .75" on heavy ply tires
- Helps maintain air pressure for the life of the tire
- Helps seal the tire bead against the wheel
- 100% water soluble for easy cleanup
- Will not rust, corrode or pit wheels
- Creates permanent repair
- Remains fluid and effective in temperatures down to -45° F
- Easily installed through existing tire valve stem with valve core removed

- ▶ 32 OZ • 2830484 • \$20 **
- ▶ 1 GALLON • 2830485 • \$72 **
- ▶ 5 GALLONS • 2830486 • \$298 **
- ▶ 5 GALLONS PUMP • 2830487 • \$133 **
- ▶ 55 GALLONS • 2830489
- ▶ 275 GALLONS • 2830488

HOW MUCH TIRE SEALANT DO YOU NEED?

$$\frac{\text{TIRE HEIGHT (IN.)} \times \text{TIRE WIDTH (IN.)}}{5} = \text{OUNCES REQUIRED PER TIRE}$$

$$\frac{27" \times 10"}{5} = 54 \text{ oz}$$

FOR A FULL APPLICATION CHART, VISIT POLARIS.COM/TIRESEALANTCHART

BRING IT EVERYWHERE

TRAILERING



CALIBER® RAMP PRO

- Designed for ATVs and UTVs up to 50" wide
 - Integrated grip glides for ultimate traction
 - Folding sides for easy transportation and storing
- ▶ 52" x 90" • 2884576 • \$694 **



ALUMINUM ARCHED LOADING RAMPS

- Capacity for up to 3,000 lbs
- ▶ 76" x 12" • 2,000 lb • 2875384 • \$359 **
- ▶ 88" x 12" • 3,000 lb • 2875386 • \$649 **



LIGHTWEIGHT TRI-FOLD RAMPS

- Ramp folds up for transport
 - Capacity for up to 1,500 lbs
 - Safety straps included
- ▶ 72" x 51" • 2875385 • \$349 **
- ▶ 82" x 51" • 2875860 • \$399 **



FOLDING ALUMINUM ARCHED RAMPS

- Ramp folds up for transport
 - Up to 1,500 lbs total capacity, 750 lb per individual ramp
 - Safety straps included
- ▶ 88" x 12" • 2875387 • \$454 **

HITCHES

3:1 HITCHES VERSATILE 3 IN 1 FUNCTIONALITY

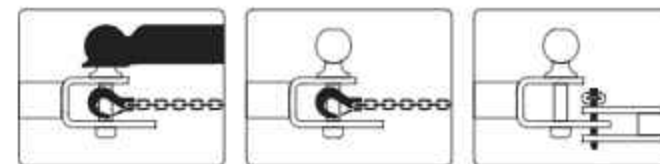

- Ball, hook and pin design
- Durable, rust resistant steel with black powdercoated finish
- Removable ball
- HD 1/2" pin and clip



HITCH WITH 2" BALL

- ▶ 2" x 2" RECEIVER 2830522 • \$39 **
- ▶ 1 1/4" x 1 1/4" RECEIVER 2830523 • \$39 **



2" HITCH BALL MOUNT

- ▶ 2" RECEIVER TONGUE 2875320 • \$44 **



1 1/2" BALL

- 1 1/2" replacement ball for hitch
 - Designed to work with 3:1 Hitch
- ▶ 2830524 • \$9 **



TRAILER BALL 1/2" SHANK

- ▶ 2" BALL • 2877603 • \$14 **
- ▶ 1 1/2" BALL • 2877602 • \$14 **

STRAPS & ROPES



RECOVERY STRAP

- 2" x 30'
 - 18,000 lb maximum load, 9,000 lb maximum vehicle weight
 - Built in strap wrap - easy storage
 - Loops sewn in to webbing
 - 1 Strap bag
- ▶ 2884033 • \$59 **



RATCHET STRAP

- 1.5" x 15' straps, 2 Pack
 - Heavy duty webbing
 - 5,500 lb maximum load, 1,833 lb working load
 - 2 Pack
- ▶ 2884031 • \$44 **



RATCHET STRAP

- 2" x 20' Ratchet Straps with heavy duty webbing
 - 10,000 lb maximum load, 3,300 lb working load
 - Floating D-Rings
 - Double J-Hooks
- ▶ 2884032 • \$34 **



SHOCK STRAPS

- 1.5" 3,000 lb breaking strength
 - Keeps tension on tie-down straps to secure load
 - 2 Pack
- ▶ 2883296 • 1.5" x 15' 1.5" • \$84 **
- ▶ 2883295 • 1.5" x 7' 1.5" • \$74 **

COVERS

2-SEAT & CREW TRAILERING COVERS

- ▶ 2880632 • 570/500/EV • \$339 **
- EV '15-21, 570 '15-23, 500 '17-23
- ▶ 2880633 • 570 CREW • \$444 **
- CREW 570-4 '15-23



3-SEAT & CREW TRAILERING COVERS

- ▶ 2883419 • XP 1000 • \$339 **
- XP 1000 '15-23, 1000 '20-23
- ▶ 2883840 • CREW XP 1000/900/DIESEL • \$444 **
- XP 1000 '18-23, CREW XP 1000 '17-23, CREW 1000 '20-23
- ▶ 2882160 • POLARIS PURSUIT CAMO SxS FIELD COVER • \$129 **
- XP 1000 '14-23, EV '11-23, 570 FULL-SIZE '17-23, 570 '14-23, 500 '11-23, 1000 '20-23

POLARIS POWER

FOR THE WORKERS, PLAYERS AND SAVE-THE-DAYERS.

BACKED BY A



WARRANTY

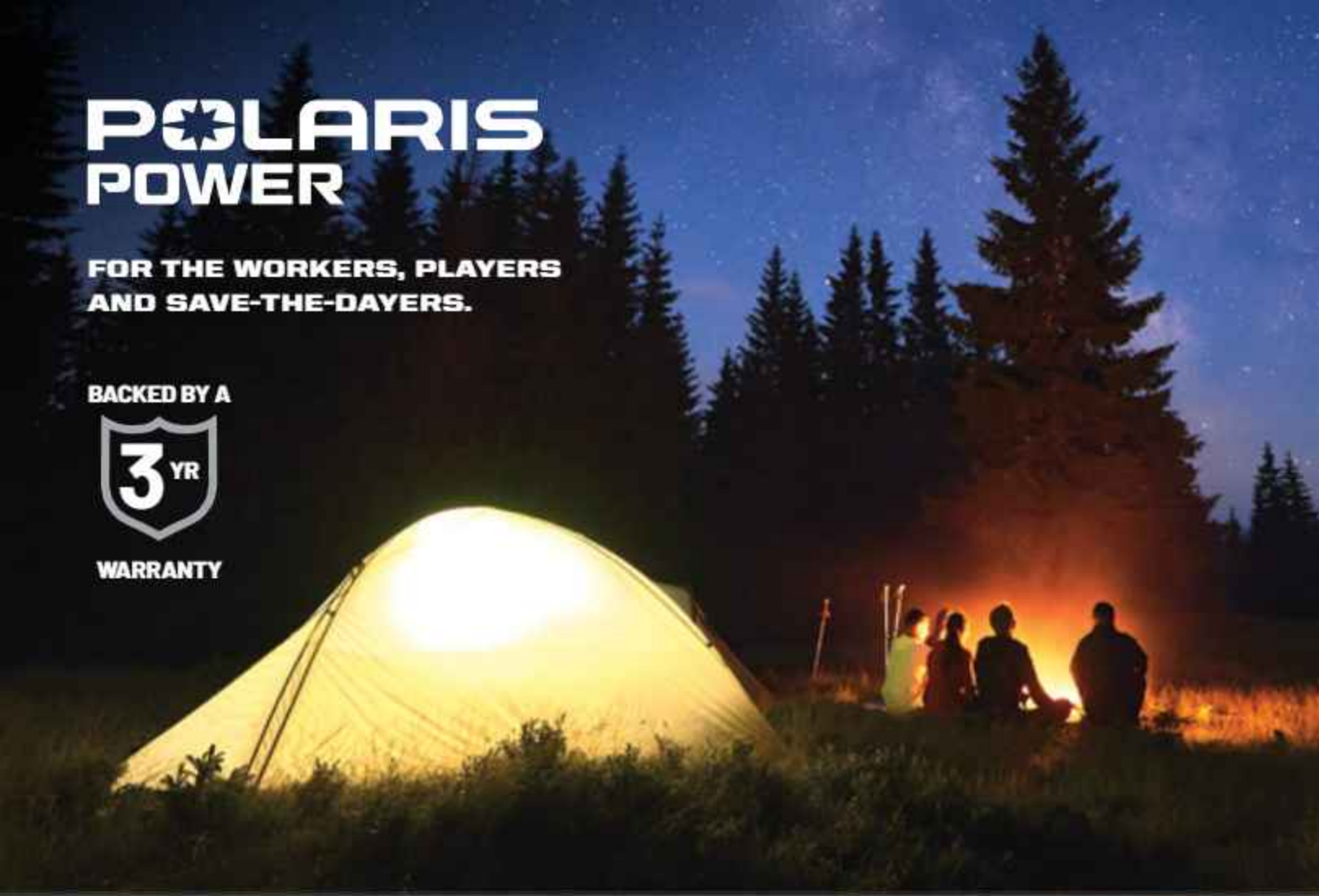

THE POWER TO EMPOWER

At Polaris Power, we are committed to powering more. We proudly donate 3% of our profits by providing portable power to areas affected by natural disasters and the organizations providing relief in North America.



VISIT POLARISPOWER.COM FOR ALL PRODUCT FEATURES



P2000i

Inverter Generator

2830532

\$799⁹⁹

1600
Running
Watts

2000
Starting
Watts

16.7
Max Amps
at 120V

7.6
Run Time at 25%
Load w/ Smart
Throttle (hrs)

62
Noise Level
at 25% Load
(dBA)

FEATURES



Extension Cord Management



Multi Functional Digital Display



Illuminated Control Panel



Multi Handle Design



Parallel Capable

BEST USED FOR



Tailgating



Off-Grid



Camping



ACCESSORIES

2830536
2830541

INVERTER PARALLEL KIT
ALL WEATHER COVER

2884866
2879383

HIGH ALTITUDE MODIFICATION KIT
GENERATOR OIL

Read, understand and follow your owner's manual. Never operate a generator indoors. Generator exhaust contains carbon monoxide vapors and exposure can result in serious injury or death. Gasoline is highly flammable and explosive under certain conditions. Always use extreme care whenever handling gasoline.

PARTS & GARAGE

MAINTENANCE

OIL LUBRICANTS

MAINTENANCE FLUIDS

GARAGE ACCESSORIES BATTERY CHARGERS

HQ PARTS

SERVICE PARTS

RESEALANT & TRAILERING

POLARIS POWER



NEW
P2500iEBT*
Inverter Generator

2830537

\$1,149⁹⁹

2000 Running Watts	2500 Starting Watts	17 Max Amps at 120V	8 Run Time at 25% Load w/ Smart Throttle (hrs)	65 Noise Level at 25% Load (dBA)
------------------------------	-------------------------------	-------------------------------	--	--

FEATURES



Polaris Mobile App Compatible



Digital Fuel Gauge



Carbon Monoxide Detection & Auto Shut Off



Electric Start with Electric Choke



Parallel Capable

BEST USED FOR



Camping



Tailgating



Off-Grid



ACCESSORIES 2830536 INVERTER PARALLEL KIT
2830540 ALL WEATHER COVER

2889540 HIGH ALTITUDE MODIFICATION KIT
2879383 GENERATOR OIL

*Check with your local dealer for availability.

P3200iE
Inverter Generator

2830533

\$1,599⁹⁹

2800 Running Watts	3200 Starting Watts	23.3 Max Amps at 120V	10.1 Run Time at 25% Load w/ Smart Throttle (hrs)	67 Noise Level at 25% Load (dBA)
------------------------------	-------------------------------	---------------------------------	---	--

FEATURES



Key Fob Remote Start



Multi Functional Digital Display



Fuel Gauge



Extension Cord Management



Parallel Capable

BEST USED FOR



Camping



One Room Backup



DIY Remodeling



ACCESSORIES 2830536 INVERTER PARALLEL KIT
2830541 ALL WEATHER COVER

2884866 HIGH ALTITUDE MODIFICATION KIT
2879383 GENERATOR OIL

Read, understand and follow your owner's manual. Never operate a generator indoors. Generator exhaust contains carbon monoxide vapors and exposure can result in serious injury or death. Gasoline is highly flammable and explosive under certain conditions. Always use extreme care whenever handling gasoline.



P5500 / P6500

2830534 / 2830535
Open Frame Generator **\$1,499⁹⁹ / \$1,699⁹⁹**

FEATURES



Extension Cord Management



Fuel Gauge



Electric Start



Rough Terrain Wheel

BEST USED FOR



Construction



Home Backup



RV'ing

5000 / 6000 Running Watts (P5500 / P6500)	5500 / 6500 Starting Watts (P5500 / P6500)	20/30 Max Amps at 120/240V	5 Run Time (hrs)	75 Noise Level (dBA)
--	---	---	-------------------------------	-----------------------------------



ACCESSORIES 2830542 ALL WEATHER COVER 2879383 GENERATOR OIL
2884867 HIGH ALTITUDE MODIFICATION KIT

Read, understand and follow your owner's manual. Never operate a generator indoors. Generator exhaust contains carbon monoxide vapors and exposure can result in severe injury or death. Gasoline is highly flammable and explodes under certain conditions. Always use extreme care whenever handling gasoline.



INTRODUCING THE POLARIS POWER PRESSURE WASHER 3700

■ 2830573 ■ PRESSURE WASHER 3700

- 3700 PSI at 2.5 GPM
- Simpson Pro-Axial Cam Pump
- CRX 4-stroke 225cc OHV engine
- Low-oil shut-down system
- 10" pneumatic tires
- Heavy-duty steel engine plate
- 1.25" tubular construction
- Professional spray gun
- 50' Morflex® hose

▶ 2830573 • \$849⁹⁹

PRESSURE WASHER ACCESSORIES



■ 2830577 ■ EXTENSION HOSE

- Designed to be highly flexible and kink resistant
- This cold water hose is equipped with standard M22 threaded connections, a dual o-ring and polyurethane outer jacket that is non-marring and abrasion-resistant for improved durability

▶ 2830577 • \$79⁹⁹



■ 2830579 ■ TURBO NOZZLE

- 3700 PSI .25" QC turbo nozzle delivers a strong jet of oscillating water that cleans faster than standard nozzles
- Made for reliability and durability, this nozzle is easy to use and great at cleaning hard to remove dirt and debris

▶ 2830579 • \$54⁹⁹



APPAREL

GEAR UP FOR YOUR ADVENTURE. Adventure invites you to gear up and make the most out of every moment, through the thrills, the fun and the memories. Live boldly on and off the trail with Polaris apparel and represent the brand that helps you get outside, stay outside, and THINK OUTSIDE.

APPAREL

PERFORMER'S & GLOVES

HELMETS & BOOTS

MEN'S APPAREL

BALL CAPS

CHILD APPAREL

WOMEN'S APPAREL

HOME & COLLECTIBLES

JERSEYS & GLOVES



OFF-ROAD RIDING JERSEYS

\$34⁹⁹ / \$29⁹⁹ (adult/youth)

Mesh ventilated panels for maximum airflow
Elastic sleeves with non-restrictive cuffs



BLACK

JERSEY | S-3XL | 2862718
GLOVES | S-3XL | 2862720
YOUTH JERSEY | S-XL | 2862723

ORANGE

JERSEY | S-3XL | 2862719
GLOVES | S-3XL | 2862729

TEAL

JERSEY | S-3XL | 2862720
GLOVES | S-3XL | 2862727
YOUTH JERSEY | S-XL | 2862724

GREEN

JERSEY | S-3XL | 2862721
GLOVES | S-3XL | 2862730

BLUE

JERSEY | S-3XL | 2862722
GLOVES | S-3XL | 2862728
YOUTH JERSEY | S-XL | 2862725

OFF-ROAD RIDING GLOVES

\$24⁹⁹

Adjustable wrist closure for a custom fit
Silicon finger grips and neoprene knuckle protection

HEATED APPAREL

Keep warm even on the coldest days with Polaris Heated Apparel. By keeping the heat close to your body, you can stay out for a longer, more comfortable ride. The Polaris Heated Apparel lineup includes the Heated Vest, Heated Base Layers and a Heated Glove Liner for both men and women. Easily control your heat setting with the touch of a button.



WOMEN'S | \$199⁹⁹
Black | S-3XL | 2833036

MEN'S | \$199⁹⁹
Black | S-3XL | 2833022



\$139⁹⁹
Black | S-3XL | 2833044

HEATED VESTS

WARMTH WITH THE TOUCH OF A BUTTON

- Perfect for any outdoor activity
- Down-proof machine washable material with 160g of insulation for warmth with or without the heater turned on
- Powered by a small rechargeable battery (included) that can also be used to charge a cellphone; battery not machine washable, remove prior to washing
- Easily adjust between four heat settings for changing weather conditions with built-in buttons

HEATED GLOVE LINER

KEEP YOUR HANDS WARM ON FROSTY DAYS

- Designed to fit under all Polaris riding gloves for an extra layer of warmth to keep you out riding longer
- Easily adjust your heat level by pressing a button on the bottom part of the glove



WOMEN'S | \$129⁹⁹
Top | S-3XL | 2833033
Bottom | S-3XL | 2833034

MEN'S | \$129⁹⁹
Top | S-3XL | 2833031
Bottom | S-3XL | 2833032

HEATED BASE LAYERS

ADJUSTABLE HEAT CLOSE TO YOUR BODY, MAXIMUM COMFORT IN CHANGING CONDITIONS

- Intended for use as a base layer
- Features lightweight, moisture-wicking fabric to give you the most comfortable layering to wear on all of your cold weather adventures, on or off the trail
- Includes multiple heat panels for evenly distributed heat for maximum warmth and comfort
- Powered by a small rechargeable battery (included) that can be used to charge a cellphone; battery not machine washable, remove prior to washing
- Easily adjust between four heat settings for changing weather conditions with built-in buttons



TEKVEST[®]
FREESTYLE
\$349⁹⁹

Black | S-3XL | 2862577



HELMETS

FOR
POLARIS

NEW
RED
XS-4XL
2833054



ALTITUDE

509 ALTITUDE 2.0 HELMET

LIGHTWEIGHT DESIGN, PERFORMANCE-INFUSED STYLE AND GOPRO® MOUNTING CAPABILITY

SHELL **\$329⁹⁵**

- Thermoplastic poly alloy outer shell

WEIGHT

- Composite as low as 1,200g
- Carbon fiber as low as 1,150g

FEATURES

- Strong, lightweight construction of carbon fiber or composite
- Superior fit for all-day comfort
- Pro Series breath box for complete protection, removable for optimal air flow
- One-piece eyepoint creates draft-free seal with 509 goggles
- Magnetic Fidlock® chin-strap technology and Integrated GOPRO® mount
- DOT- and ECE 22.05-approved

FIDLOCK



NEW
RADIANT GREEN
XS-4XL
2833051



BLACK
XS-4XL
2861409



\$429⁹⁵
CARBON FIBER
BLACK/LIME
XS-4XL
2861473

FOR
POLARIS

NEW
PINK
XS-4XL
2833050



TACTICAL

TACTICAL 2.0 HELMET

COMBINES STYLE WITH VERSATILITY FOR ULTIMATE COMFORT AND CONTROL

SHELL **\$229⁹⁵**

- Shock-resistant, injection-molded thermoplastic

FEATURES

- Innovative Venturi Vent pulls moist air from helmet without cold wind coming in
- Eyepoint seal is co-integrated with the removable breath box and creates a draft-free seal with 509 goggles and a clear field of view
- Magnetic Fidlock® chin-strap technology
- DOT- and ECE 22.05-approved

FIDLOCK



MATTE BLACK
XS-4XL
2862468



GRAY
XS-4XL
2862469



RED/BLACK
XS-4XL
2862467



ORANGE
XS-4XL
2862471



NEW
BLUE
XS-2XL
2833143

TENACITY

TENACITY 4.0 HELMET

COMBINATION OF MODERN STYLE AND PREMIUM PROTECTION WITH INCREDIBLE VALUE

SHELL **\$139⁹⁹**

- Shock-resistant, injection-molded thermoplastic

WEIGHT

- 1,500g

FEATURES

- Through-flow, full-helmet ventilation
- ProClip quick release chin strap allows you to fasten the chin strap in seconds
- Removable breath box and removable, washable liner
- Tool-free adjustable roost shield
- DOT- and ECE 22.05-approved



NEW
RADIANT GREEN
XS-2XL
2833142



BLACK
XS-2XL
2861557



BLACK/GRAY
XS-2XL
2861558



BLACK/LIME
XS-2XL
2861559



WHITE/RED
XS-2XL
2861561



PINK
XS-2XL
2861562

GOGGLES



ORANGE
2862561



LIME
2862559

509 KINGPIN OFF-ROAD GOGGLE

PREMIUM MATERIALS, ATTRACTIVE PRICE **\$49⁹⁵**

FEATURES

- Oversized spherical lens delivers optimal peripheral vision
- Metal tear-off posts provide strength and durability
- Quick-change technology allows you to run the best lens tint for conditions



BLUE
2862562



STEALTH
2862560

509 MX6 OFF-ROAD GOGGLE

SUPER WIDE FIELD OF VIEW, ENGINEERED FOR DIRT **\$99⁹⁵**

FEATURES

- PC outer lens with anti-scratch coating, and internal anti-fog coating
- Outriggers with latch system for quick lens change
- 45mm strap with silicone to hold strap in place



BLACK
2862557



RED/BLACK
2862558



RED/GRAY
S-3XL | 2833029

BLACK
S-3XL | 2861432

FORCE PUFFER JACKET

PACKABLE JACKET OFFERS LIGHTWEIGHT PROTECTION, IDEAL FOR ANY ACTIVITY

- 140g 3M* Thinsulate*
- Plenty of storage with two external hand pockets and one internal media pocket
- Rugged YKK® zippers
- Great for travel, compacts into pocket

\$139 99



ORANGE
S-3XL | 2833027

BLUE
S-3XL | 2833028

BLACK
S-3XL | 2861434

SOFTSHELL JACKET

VERSATILE LIGHTWEIGHT JACKET THAT'S PERFECT FOR EVERYDAY WEAR

- Casual jacket armed with rugged and warm features for everyday wear
- Superior DWR prevents precipitation from saturating the jacket's exterior
- Lined with soft fleece for warmth
- Removable hood and underarm venting, three external pockets and one internal chest pocket

\$129 99



BLACK
S-3XL | 2862569

NAVY
S-3XL | 2862570

WORK VEST

RUGGED AND DURABLE VEST THAT'S IDEAL AS AN OUTDOOR LAYER

- Made of durable nylon fabric to make it the ideal vest for work
- 80g 3M* Thinsulate* insulation provides great warmth
- Vest comes with plenty of pockets to store your valuables

\$99 99



GRAY
S-3XL | 2860863

BLACK
S-3XL | 2861608

WORK JACKET

WARM AND RUGGED JACKET THAT'S TOUGH FOR WORK AND STYLISH FOR PLAY

- Coated with Durable Water Repellency (DWR) to provide water-resistance
- Built in action back for increased range of motion
- 80g 3M* Thinsulate* for added warmth with brushed flannel trim
- One inner and four outer pockets for storage

\$159 99

REVOLVE VEST

REVERSIBLE

DURABLE AND WARM REVERSIBLE VEST OFFERS TWO STYLES IN ONE

- Durable windbreak outer fabric helps protect from the elements
- 140g 3M* Thinsulate* insulation keeps you warm in cold weather
- Reversible vest offers two unique styles in one

\$99 99



RED
S-3XL | 2833030

BLACK/GRAY
S-3XL | 2862565

WINDBREAKER JACKET

LIGHTWEIGHT, WINDPROOF JACKET THAT PROVIDES PROTECTION WHILE RIDING

- 100% polyester windproof fabric
- Lightweight construction makes it easy to pack
- Three external pockets allow for maximum storage

\$99 99



BLACK
S-3XL | 2861541

FLANNEL JACKET

SHERPA FLEECE LINED JACKET DELIVERS EXCEPTIONAL WARMTH AND COMFORT

- Warm sherpa lined fleece material
- Insulation to keep you warm
- Plenty of storage for your valuables

\$99 99



CHARCOAL
S-3XL | 2860865

BRONZE
S-3XL | 2860864





STAMP HOODIE

\$54.99

■ **Navy** Green | S-3XL | 2833061
 Black | S-3XL | 2862484
 Navy | S-3XL | 2861500



CREW SWEATSHIRT

\$49.99

■ **Navy** Gray | S-3XL | 2833067
 Black | S-3XL | 2862488
 Navy | S-3XL | 2861497



ICON HOODIE

\$54.99

■ **Navy** Black/Red | S-3XL | 2833065
 Gray | S-3XL | 2862487
 Green | S-3XL | 2861495



TITAN MID-LAYER

\$89.99

■ **Navy** Red | S-3XL | 2833026
 Black | S-3XL | 2862568
 Blum/Orange | S-3XL | 2862567



NORTHSTAR MID-LAYER

\$89.99

■ **Navy** Black/Lime | S-3XL | 2833024
 Tan | S-3XL | 2862450



JOURNEY HOODIE

\$69.99

■ **Navy** Navy | S-3XL | 2833066
 Black | S-3XL | 2862489



ICON LONG SLEEVE

\$29.99

■ **Navy** Lime | S-3XL | 2833083
 Gray/Red | S-3XL | 2862505
 Black | S-3XL | 2861584



DASH LONG SLEEVE

\$29.99

■ **Navy** Black/Red | S-3XL | 2833082
 Navy | S-3XL | 2861583
 Black | S-3XL | 2861582



PERFORMANCE LONG SLEEVE

\$39.99

■ **Navy** Gray | S-3XL | 2833168
 Black | S-3XL | 2862507



STAPLE HOODIE

\$54.99

Black | S-3XL | 2833068
 Navy | S-3XL | 2833069
 Green | S-3XL | 2833070



TECH FULL-ZIP HOODIE

\$64.99

■ **Navy** Red | S-3XL | 2833064
 Gray | S-3XL | 2861493



ROGUE HOODIE

\$54.99

■ **Navy** Black | S-3XL | 2833062
 Navy | S-3XL | 2833063
 Gray | S-3XL | 2862485



ICON TEE

\$24.99

■ **Navy** Lime | S-3XL | 2833079
 Green | S-3XL | 2862501
 Black | S-3XL | 2861570



GRAPHIC TEE

\$24.99

Dark Gray | S-3XL | 2833086
 Forest Green | S-3XL | 2833087



FLAG TEE

\$24.99

Navy | S-3XL | 2862500
 White | S-3XL | 2862582

APPAREL

PERFORMERS & GLOVES
 B-HETERED APPAREL

HELMETS & BOOTS

MEN'S APPAREL

BALL CAPS

CHILD APPAREL

WOMEN'S APPAREL

HOME
 & COLLECTIBLES

BALL CAPS



NEW
LEATHER PATCH HAT

\$24.99
Black | One Size | 2833129
Gray | One Size | 2833130



NEW
STAPLE CAP

\$24.99
Black | One Size | 2833127
Navy | One Size | 2833128



HIGHLAND CAP

\$24.99
NEW Navy | One Size | 2833126
Tan | One Size | 2860893
Gray | One Size | 2862544



ELLIPSE PATCH TRUCKER HAT

\$24.99
Orange | One Size | 2833124
Light Gray | One Size | 2862539
Gray | One Size | 2861531
Black | One Size | 2861533
Navy | One Size | 2861532



CORE CAP

\$24.99
NEW Red | One Size | 2833123
Gray | One Size | 2862594
Navy | One Size | 2861523
Black | One Size | 2861524



TONAL HAT

\$24.99
Black/Red | One Size | 2861526
Navy | One Size | 2861525



NEW
JOURNEY CAP

\$24.99
Black | One Size | 2833136
Blue | One Size | 2833137



CHECKERED HAT

\$24.99
Blue | One Size | 2861520
Black | One Size | 2861522
Gray | One Size | 2861521



RETRO CAP

\$24.99
NEW Black | One Size | 2833125
Navy | One Size | 2862538
Gray/Red | One Size | 2869542
Gray/Orange | One Size | 2861536

CAMO APPAREL



CAMO SOFTSHELL JACKET

\$129.99
Camo | S-3XL | 2861543



MEN'S CAMO REVOLVE VEST

\$99.99
Camo | S-3XL | 2862572



MEN'S CAMO PURSUIT HOODIE

\$49.99
Camo | S-3XL | 2862484



WOMEN'S CAMO PURSUIT HOODIE

\$49.99
Camo | S-3XL | 2862517



NEW
PURSUIT HOODIE

\$54.99
Black | S-3XL | 2833076
Green | S-3XL | 2833077



CAMO NECK GAITER

\$12.99
Camo | One Size | 2861948



STEALTH CAMO HAT

\$24.99
Camo | One Size | 2861527



HUNTER ORANGE HAT

\$24.99
Orange | S/M | 2860892
Orange | L/XL | 2862545



HUNTER ORANGE BEANIE

\$19.99
Orange | One Size | 2862595

APPAREL

PERFORM & GLOVES
HEATED APPAREL

HELMETS & BOOTS

MEN'S APPAREL

BALL CAPS

CAMO APPAREL

WOMEN'S APPAREL

HOME
& COLLECTIBLES



NEW
RADIANT GREEN
S-3XL | 2833039

BLACK
S-3XL | 2862457

NEW
BLACK
S-3XL | 2833041

NEW
RADIANT GREEN
S-3XL | 2833048

BLUE
S-3XL | 2862460

REVOLVE VEST

DURABLE AND WARM REVERSIBLE VEST OFFERS TWO STYLES IN ONE

- Durable windbreak outer fabric protects you from the elements
- 140g 3M[®] Thinsulate[®] insulation keeps you warm in cold weather
- Reversible for two unique styles in one

\$99⁹⁹

SOFTSHELL JACKET

VERSATILE LIGHTWEIGHT JACKET THAT'S PERFECT FOR EVERYDAY WEAR

- Casual jacket armed with rugged and warm features
- Superior DWR prevents precipitation from saturating the jacket's exterior
- Lined with 280g of soft fleece for warmth
- Removable hood and underarm venting
- Three external pockets and one internal chest pocket

\$129⁹⁹



BLACK
S-3XL | 2861433

FORCE PUFFER JACKET

PACKABLE JACKET OFFERS LIGHTWEIGHT PROTECTION AND INCREDIBLE WARMTH

- 140g 3M[®] Thinsulate[®]
- Two external hand pockets, one internal media pocket
- Rugged YKK[®] zippers
- Compactable into travel pocket

\$139⁹⁹



BLACK
S-3XL | 2862563

BLUE
S-3XL | 2862564

WORK JACKET

WARM AND RUGGED JACKET THAT'S TOUGH FOR WORK AND STYLISH FOR PLAY

- 100% nylon shell is coated with DWR to help keep you dry
- 80g 3M[®] Thinsulate[®] for added warmth with brushed flannel trim
- Built-in action back for increased range of motion
- One inner and four outer pockets for storage

\$159⁹⁹



NEW
RADIANT GREEN
S-3XL | 2833042

BLACK/GRAY
S-3XL | 2862458

TITAN MID-LAYER

EXTREMELY WARM YET BREATHABLE MID-LAYER, PERFECT FOR RIDING

- 319g Polartec[®] Thermal Pro[®] Rib Sweater provides great warmth
- Breathable material moves sweat to the outer surface
- Nylon overlay is comfortable and light

\$89⁹⁹



NEW
STAPLE HOODIE

\$54⁹⁹

Black | S-3XL | 2833095
Gray | S-3XL | 2833096



JOURNEY HOODIE

\$69⁹⁹

NEW Radiant Green | S-3XL | 2833098
Black | S-3XL | 2862515
Blue | S-3XL | 2862516



TECH FULL-ZIP HOODIE

\$64⁹⁹

NEW Black | S-3XL | 2833097
Maroon | S-3XL | 2861509
Gray | S-3XL | 2861508



ICON HOODIE

\$54⁹⁹

NEW Gray | S-3XL | 2833099
White | S-3XL | 2862512



ADVENTURE CREW

\$49⁹⁹

NEW Black/Radiant Green | S-3XL | 2833100
NEW Green | S-3XL | 2833101
Dusty Rose | S-3XL | 2862513
Black | S-3XL | 2862514



NEW
ADVENTURE LONG SLEEVE

\$29⁹⁹

Gray | S-3XL | 2833107
Navy | S-3XL | 2833108



NEW
CORE TANK

\$19⁹⁹

Black | S-3XL | 2833161
Gray | S-3XL | 2833160



NEW
FLAG TEE

\$24⁹⁹

Gray | S-3XL | 2833163
White | S-3XL | 2833162



ADVENTURE TEE

\$24⁹⁹

NEW Pink | S-3XL | 2833104
Black Frost | S-3XL | 2862628
Teal | S-3XL | 2862629



RETRO CLOCK
12" | 2860662 | \$29⁹⁹



NEW
POLARIS LED SIGN
31.5" x 6.5" | 2862736 | \$259⁹⁹



ALUMINUM SIGN
22" | 2860867 | \$129⁹⁹



WOOD SIGN
24" x 10.5" | 2860866 | \$74⁹⁹



RETRO GLASSES (SET OF 2)
2860265 | \$14⁹⁹



12oz CAMPER MUG
2861612 | \$29⁹⁹



23oz WATER BOTTLE
2862685 | \$24⁹⁹



WOODEN COASTERS
2860869 | \$24⁹⁹



HITCH COVER
2861623 | \$34⁹⁹



LICENSE PLATE HOLDER
2862687 | \$19⁹⁹



POLARIS PARKING SIGN
2869934 | \$19⁹⁹



POLARIS FLAG
5' x 3' | 2869928 | \$24⁹⁹



15oz CAMPFIRE MUG
2861613 | \$19⁹⁹



PREMIUM KOOZIE
2860829 | \$7⁹⁹



LEATHER LOOP KEYCHAIN
2861615 | \$14⁹⁹



KEYCHAIN
2861614 | \$6⁹⁹



KICKBACK ROCKER
2862626 | \$55⁰⁰



FREESTYLE ROCKER
2862625 | \$65⁰⁰



EASY CHAIR
2862627 | \$45⁰⁰



QUICK-E-SEAT
2862624 | \$35⁰⁰



FOLDABLE TABLE
2861620 | \$49⁹⁹



POP-UP TRASH BIN
2861622 | \$19⁹⁹



FLASK
2860812 | \$24⁹⁹



DECK OF CARDS
2860816 | \$14⁹⁹

OGIO

LEARN ABOUT OUR LINE OF OGIO® BAGS ONLINE AT
RANGER.POLARIS.COM/OGIOLUGGAGE



THE MOST CAPABLE UTV.
GET MORE DONE.

Trusted by farmers, ranchers, hunters and homeowners for more than a decade.



Availability varies by market, check your local dealer for availability. Never transport a loaded firearm. Firearm is unloaded prior to mounting. Please refer to local laws and regulations regarding the requirements for the legal transport of firearms.

Warning: Polaris off-road vehicles can be hazardous to operate and are not intended for on-road use. Driver must be at least 16 years old with a valid driver's license to operate. All riders should always wear helmets, eye protection and protective clothing and footwear. Read, understand and follow your owner's manual. Ride within the limits of your own abilities and never engage in stunt or exhibition driving. Never ride under the influence of drugs or alcohol. All riders should take a safety training course. Call 800-340-3764 for additional information.

Unless noted, trademarks are the property of Polaris Industries Inc. 3M® and Thinsulate® are registered trademarks of 3M Company. 500P® is a registered trademark of Teton Outfitters, LLC. App Store® is a registered trademark of Apple Inc. BatteryMINDer® is a registered trademark of VDC Electronics Inc. Bluetooth® is a registered trademark of Bluetooth SIG, Inc. Carhart® is a registered trademark of Carhartt, Inc. Facebook® is a service trademark of Facebook, Inc. FidoLock® is a registered trademark of FidoLock GmbH. FOX® is a registered trademark of Fox Factory Inc. Google Play™ is a service trademark of GOOGLE LLC. GoPro® is a registered trademark of GoPro Inc. HomeLink® is a registered trademark of Genie Corporation. Instagram™ is a service trademark of Instagram, LLC. JB® is a registered trademark of HANMAN INTERNATIONAL INDUSTRIES, INCORPORATED. KOLPIN® and KOLPIN STRONGHOLD® are registered trademarks of Polaris Industries Inc. M8i Quar® is a registered trademark of Maxsonics USA Inc. MOBILIZER® is a registered trademark of INA Group, Inc. NOCO Gear® is a registered trademark of The Noco Company. Otter® is a registered trademark of Otter Outdoors, LLC. Polartec® is a registered trademark of 3M IPCO, LLC. Rhino Grip® is a registered trademark of Polaris Industries, Inc. RHINO RACK® is a registered trademark of Rhino Rack Australia Pty Limited. RIDGE® is a trademark of JST Performance, LLC d/b/a Rigid Industries LLC. SMART BOARD® is a registered trademark of SMART TECHNOLOGIES LLC UNLIMITED LIABILITY CORPORATION CANADA. Tiger Oryx® is a registered trademark of Tiger Coatings GmbH & Co. KG. TRXV51® is a registered trademark of TRXV51 ONTARIO INC. Twitter™ is a registered trademark of Twitter, Inc. WALKER EVANS RACING® is a registered trademark of Walker Evans Enterprises Incorporated. Yeti® is a registered trademark of Yeti Coolers, LLC. YKK® is a registered trademark of YKK Corporation. YouTube® is a registered trademark of Google LLC. Prices, fitment and availability are subject to change at any moment. Copyright © 2022 Polaris Industries Inc. All rights reserved.

HARDEST WORKING.

SMOOTHEST RIDING.

GET THE BEST OWNER EXPERIENCE OUT THERE

Our goal is to make every day of ownership a smooth ride. Sign in for access to everything you need, plus exclusive offers and more.

[OFFROAD.POLARIS.COM/ACCOUNT](https://offroad.polaris.com/account)



MY GARAGE

- Vehicle Profile & Accessory Details
- Maintenance Schedules
- Schedule Service
- Manuals & Warranty Info



MY RIDES & COMMUNITY

- My Tracked Rides
- My Planned Routes & POIs
- My Community Activities & Events
- Explore Polaris Adventures



MY SHOPPING

- Recommended Accessories
- Purchase History
- My Dealer
- Access to Polaris Pros



CONNECT ONLINE
SEARCH "PolarisORV"



TAKE ON

ANY ENVIRONMENT

1 CHOOSE MODEL

2 CHOOSE TRIM

3 CHOOSE COLOR

4 CHOOSE ACCESSORIES



[VISIT POLARIS.COM/RANGER](https://polaris.com/ranger)

TO SEE VEHICLE OPTIONS AND VIEW ACCESSORIES
ON YOUR NEW MACHINE FROM EVERY ANGLE!

POLARIS

Think Outside

MY23 RGR APP ACC US - AUG '22