



POLARIS *GENERAL*

2023

ACCESSORIES,
GARAGE & APPAREL

US VERSION

UNLOCK MORE ADVENTURE

Off-road's premier family of adventure side-by-sides. No matter which GENERAL you choose, you begin every adventure with ultimate versatility for play and work, comfort for the long haul, and performance where it matters. When you customize with Polaris Engineered Accessories you have the confidence to take on any task or any trail.



BRING IT ALL. BRING IT ON.

Industry-exclusive Rhino-Rack® storage solutions for GENERAL. Transform your vehicle for work, play or anything in between with durable and easy-to-use bed racks and load securing attachments.

2023 LINEUP

SEE THE FULL LINEUP AT [POLARIS.COM/GENERAL](https://www.polaris.com/general)

GENERAL XP

XP 1000 ULTIMATE (2 & 4 SEAT)



XP 1000 SPORT FEATURES PLUS:
 RIDE COMMAND 7" GLOVE-TOUCH DISPLAY
 STAGE 3 AUDIO SYSTEM BY ROCKFORD FOSGATE®
 FRONT AND REAR ONBOARD CAMERAS
 POLARIS HD 4,500 LB. WINCH WITH AUTOSTOP
 & PLOW MODE

XP 1000 PREMIUM (2 & 4 SEAT)



XP 1000 SPORT FEATURES PLUS:
 ROCKFORD FOSGATE® PMX HEAD UNIT
 STAGE 1 AUDIO SYSTEM BY ROCKFORD FOSGATE®
 PREMIUM PAINTED PANELS

XP 1000 SPORT (2 & 4 SEAT)



CLASS-LEADING 100 HORSEPOWER
 CLASS-LEADING 14" SUSPENSION TRAVEL
 WITH HIGH CLEARANCE A-ARMS
 POLARIS HD 4,500 LB. WINCH
 SPORT ROOF
 SPORT LOW PROFILE FRONT BUMPER
 30" PRO ARMOR CRAWLER XGF/XG OR ITP ULTRA
 CROSS® R SPEC TIRES

GENERAL

1000 SPORT (2 SEAT)



CLASS-LEADING 100 HORSEPOWER
 CLASS-LEADING 600 LB. DUMPING CARGO BOX
 HALF DOORS
 ELECTRONIC POWER STEERING (EPS)
 VERSATRAC TURF MODE

CONTENTS

ACCESSORIES 06

WINDSHIELDS & REAR PANELS	08
DOORS	10
ROOFS	12
VEHICLE & RIDER PROTECTION	13
STORAGE	14
CAB COMFORT	17
HUNT	18
POLARIS NORTHSTAR COOLERS	20
CONNECTED TECHNOLOGY	22
AUDIO	24
LIGHTING	26
WHEELS & TIRES	28
WINCHES	36
PLOWS & TRACKS	37

PARTS & GARAGE 38

MAINTENANCE	38
OIL & LUBRICANTS	40
MAINTENANCE FLUIDS	42
GARAGE ACCESSORIES & BATTERY CHARGERS ..	44
HD PARTS	46
SERVICE PARTS	48
TIRE SEALANT & TRAILERING	50
POLARIS POWER	52

APPAREL 58

JERSEYS & GLOVES & HEATED APPAREL	58
HELMETS & GOGGLES	60
MEN'S APPAREL	62
BALL CAPS	66
CAMO APPAREL	67
WOMEN'S APPAREL	68
HOME & COLLECTIBLES	70



BUILD YOUR OWN
 AT [POLARIS.COM/GENERAL](https://www.polaris.com/general)

DESIGNED

by the people who designed your vehicle.



TESTED

extensively in the field so you ride with 100% confidence.



TRUSTED

65 years in the business.
The #1 name in Off-Road.

ACCESSORIES
BACKED BY A



WARRANTY



RHINO-RACK®

Rhino-Rack® storage solutions designed specifically for Polaris GENERAL. From opposite sides of the globe, some of the most capable machines in the off-road world meet a trusted outdoor adventure brand to deliver industry-exclusive bed racks and accessories to help Polaris GENERAL users have more fun and get more done. Designed for perfect integration and tested to off-road standards, a Rhino-Rack®-equipped GENERAL will help you get more storage capacity out of your machine — so you can stay prepared for whatever the day may bring.



WE HOLD OUR PARTNERS TO THE SAME STANDARDS

PRO ARMOR



WHEELS, TIRES & LIGHTING DESIGNED WITH
POLARIS TO MAXIMIZE PERFORMANCE
P. 27 & 28



Rockford Fosgate

A GLOBAL LEADER IN AUDIO INNOVATION,
DESIGN & ENGINEERING
P. 24

RIGID

PRODUCTS SO GOOD THEY REPLACE
OR REPAIR THEM FOR LIFE
P. 26

KOLPIN
OUTDOORS

MAKING PRODUCTS FOR AVID
SPORTSMEN SINCE 1943
P. 18



TRAIL TECH

DIGITAL GAUGES FOR
POWERSPORTS RIDERS
P. 23



RHINO-RACK®

BRING IT ALL.
BRING IT ON.
P. 14

ENGINEERED TO TAKE ON THE ELEMENTS

TESTED & PROVEN



DUST



WIND

BUILD YOUR CAB SYSTEM STARTING ON P. 08



COMFORT YOU HAVE TO EXPERIENCE TO BELIEVE

Our cab components create an experience enhancing interior, offering supreme comfort to your vehicle.



PROFILE TUBE DESIGN

Contours built into the cage deliver a premium sealing surface.



PERFECT FIT, PERFECT SEAL

A 360° gasket seal provides our tightest-sealing cab.



LOCK & RIDE EASY ON & OFF

Adapt to your needs and environment with exclusive tool-less, easy-on, easy-off Lock & Ride components.



PLUG & PLAY ELECTRICAL

EFFORTLESSLY ADD LIGHTS, HEAT, WIPERS & AUDIO.

A revolution in electrical accessory integration, the Polaris PULSE Electrical System allows for a simple plug & play approach for adding power to Polaris Engineered Accessories.

Look for  to identify Polaris PULSE ready accessories.





UNLOCK MORE ADVENTURE

- LOCK & RIDE** Vented Windshield - Hard Coat Poly: P. 08
- Windshield Wiper & Washer System: P. 08
- Rear Sport Bumper: P. 13
- Extreme Kick-Out Rock Sliders: P. 13
- Rhino-Rack® Rear Bed Rack: P. 14
- Polaris Northstar 15 QT Cooler: P. 21
- Pro Armor 33" Combo LED Light Bar: P. 27
- Light Bar Harness: P. 27



BLAZE A NEW TRAIL

- LOCK & RIDE** Vented Windshield - Hard Coat Poly: P. 08
- Sport Roof - Poly: P. 12
- XL Fender Flares: P. 13 **NOT SHOWN**
- LOCK & RIDE** Cargo Box: P. 16
- RIGID® SR-Series Combo Light Bar: P. 27
- Pro Armor Wheel & Tire Set: P. 35
- 29" Mud XC & 14" 4204 - Matte Black
- Winch: P. 36



PREPARE FOR THE HUNT

- LOCK & RIDE** Full Windshield - Glass: P. 08
 - Windshield Wiper & Washer System: P. 08
 - LOCK & RIDE** Rear Panel - Glass: P. 09
 - Polaris PULSE LED Light Bar Harness: P. 17
 - Rear Adventure Rack: P. 19
 - Pro Armor 33" Combo LED Light Bar: P. 27
- In addition to stock accessories



SPORT ESSENTIALS

- LOCK & RIDE** Full Windshield - Glass: P. 08
- Windshield Wiper & Washer System: P. 08
- LOCK & RIDE** Rear Panel - Glass: P. 09
- Premium Roof - Poly: P. 12
- Polaris Northstar 30 QT Cooler: P. 20

WINDSHIELDS

Keep the elements out and control air flow into the cab.

POLARIS ENGINEERED ADVANTAGES

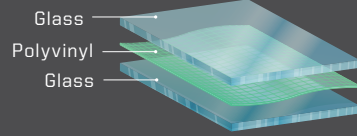

GLASS VS POLY

- Superior optical clarity (automotive level)
- Scratch-resistant
- Curved to fit, seals tight
- Cold weather / heavy duty
- Wiper ready (windshield only)

- Lightweight, flexible, easy to store/remove
- Impact-resistant
- Tight seal keeps out rain and dust
- Hard Coat: 30x more scratch resistance than regular poly windshields

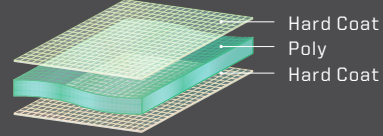

LOCK & RIDE
REVOLUTIONARY
INSTALLATION



**AIRTIGHT
GASKET SEAL**

GLASS

HARD COAT POLY

POLY



TIP-OUT WINDSHIELD - GLASS TOP SELLER

» 2881108 • \$1,399⁹⁹
POLARIS GENERAL XP 1000/4 '20-23
POLARIS GENERAL 1000/4 '16-23

LOCK & RIDE FULL WINDSHIELD - GLASS TOP SELLER

» 2889064 • \$829⁹⁹
POLARIS GENERAL XP 1000/4 '20-23
POLARIS GENERAL 1000/4 '16-23

LOCK & RIDE VENTED WINDSHIELD - HARD COAT POLY

» 2884223 • \$649⁹⁹
POLARIS GENERAL XP 1000/4 '20-23
POLARIS GENERAL 1000/4 '16-23

LOCK & RIDE FLIP-DOWN WINDSHIELD - HARD COAT POLY

» 2889156 • \$639⁹⁹
POLARIS GENERAL XP 1000/4 '20-23
POLARIS GENERAL 1000/4 '16-23

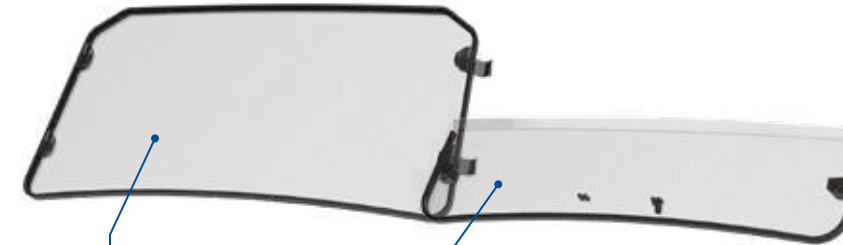

LOCK & RIDE FULL WINDSHIELD - HARD COAT POLY

» 2884337 • \$569⁹⁹
POLARIS GENERAL XP 1000/4 '20-23
POLARIS GENERAL 1000/4 '16-23

LOCK & RIDE HALF WINDSHIELD - POLY

» 2881111 • \$249⁹⁹
POLARIS GENERAL XP 1000/4 '20-23
POLARIS GENERAL 1000/4 '16-23



WINDSHIELD WIPER & WASHER SYSTEM TOP SELLER

» 2881090 • \$589⁹⁹
POLARIS GENERAL XP 1000/4 '20-23
POLARIS GENERAL 1000/4 '16-23



Offers fully-sealed or flipped-down venting options. Upper half detaches, leaving lower half for protection with maximum ventilation.

REAR PANELS

Turbulent air forms above the cargo bed and behind the cab when you add a windshield. This swirl can carry dirt, dust, leaves, and rain into the cab. Eliminate this phenomenon and control the swirl by installing a rear panel.



LOCK & RIDE REAR PANEL - GLASS TOP SELLER

» 2881113 • \$499⁹⁹
POLARIS GENERAL XP 1000/4 '20-23
POLARIS GENERAL 1000/4 '16-23



LOCK & RIDE REAR PANEL - POLY TOP SELLER

» 2881112 • \$399⁹⁹
POLARIS GENERAL XP 1000/4 '20-23
POLARIS GENERAL 1000/4 '16-23

ADD A REAR PANEL TO REDUCE THE DUST SWIRL

ACCESSORIES

WINDSHIELDS & REAR PANELS

DOORS

ROOFS & PROTECTION

STORAGE, CAB COMFORT & HUNT

COOLERS

CONNECTED TECHNOLOGY & AUDIO

LIGHTING

WHEELS & TIRES

WINCHES, PLUGS & TRACKS

DOORS

COMPLETE YOUR CAB. Polaris GENERAL comes equipped with half doors. To create an enclosed cab for increased protection from the elements, choose from two great Polaris options.



REPLACE STOCK HALF DOORS

PREMIUM POLY FULL DOORS

- Impact and scratch-resistant tempered glass
- Fully-sealed design keeps elements out for a premium in-cab environment
- Hinged window adjustability
- Soft-touch, easy-to-clean premium interior liner

2-SEAT

- Six-way glass window adjustability

» 2889809 • **\$3,249⁹⁹**
 POLARIS GENERAL XP 1000/4 '20-23
 POLARIS GENERAL 1000/4 '16-23

4-SEAT

- Push-out windows
- Kit includes B-pillar cover seal

» 2889810 • **\$3,249⁹⁹**
 POLARIS GENERAL XP 4 1000 '20-23
 POLARIS GENERAL 4 1000 '17-23



POLARIS ENGINEERED ADVANTAGES



PREMIUM INTERIOR HANDLE AND LINER



A PERFECT FIT FOR THE PERFECT SEAL



ADD UPPER DOORS TO STOCK HALF DOORS

ZIP WINDOW UPPER DOORS

- Durable, rugged canvas stitched over a robust steel frame
- Lightweight, UV-resistant construction
- Retention straps for increased strength
- Zipper windows for increased venting options
- Mounts easily by drilling into stock doors (drill hole plugs included)

2-SEAT

» 2882548 • **\$879⁹⁹**
 POLARIS GENERAL XP 1000 '20-23
 POLARIS GENERAL 1000 '18-23

NOT SHOWN

4-SEAT

» 2883453 • **\$1,719⁹⁹**
 POLARIS GENERAL XP 4 1000 '20-23
 POLARIS GENERAL 4 1000 '18-23

RHINO-RACK® STORAGE SOLUTIONS

SEE P. 14



ROOFS

Protect yourself from the elements. The right roof shields you from the sun and driving rain.

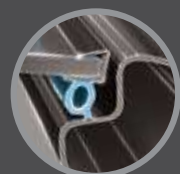

A PERFECT FIT FOR THE PERFECT SEAL

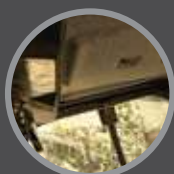

PREMIUM FEATURES & QUIETER RIDE

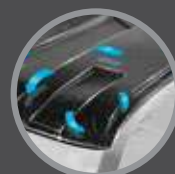

KEEP MOISTURE MOVING

POLARIS ENGINEERED ADVANTAGES

ALUMINUM VS POLY

- | | |
|--|---|
| <ul style="list-style-type: none"> • High protection strength • Lower profile • Sleek style | <ul style="list-style-type: none"> • Water run-off • Pre-existing mounting features • Liner ready • Lightweight |
|--|---|

2-SEAT

ROOF - ALUMINUM

» 2881105 • \$434⁹⁹
POLARIS GENERAL XP 1000 '20-23
POLARIS GENERAL 1000 '16-23



PREMIUM ROOF - POLY

» 2883800 • \$659⁹⁹
POLARIS GENERAL XP 1000 '20-23
POLARIS GENERAL 1000 '16-23



INCLUDES PREMIUM ROOF LINER

TOP SELLER SPORT ROOF - POLY

» 2883780 • \$449⁹⁹
POLARIS GENERAL XP 1000 '20-23
POLARIS GENERAL 1000 '16-23



4-SEAT

PREMIUM ROOF - POLY

» 2883801 • \$1,049⁹⁹
POLARIS GENERAL XP 4 1000 '20-23
POLARIS GENERAL 4 1000 '17-23

INCLUDES PREMIUM ROOF LINER

TOP SELLER SPORT ROOF - POLY

» 2883781 • \$699⁹⁹
POLARIS GENERAL XP 4 1000 '20-23
POLARIS GENERAL 4 1000 '17-23

POLY ROOF LINER

» 2883802 • \$364⁹⁹
POLARIS GENERAL XP 4 1000 '20-23
POLARIS GENERAL 4 1000 '17-23
Compatible with Sport Roof - Poly (2883781), sold separately

VEHICLE & RIDER PROTECTION

Arm your Polaris GENERAL with Polaris Engineered bumpers and guards to take on any challenge. Engineered for easy, secure installation; providing added protection for lights, bodywork and suspension.



ROCK SLIDERS NOT SHOWN

LOW PROFILE

» 2881102 • \$299⁹⁹
POLARIS GENERAL 1000 '16-23
Not compatible with XL Fender Flares

EXTREME KICK-OUT

• Compatible with XL Fender Flares
» 2-SEAT • 2881101 • \$324⁹⁹
POLARIS GENERAL XP 1000 '20-23
POLARIS GENERAL 1000 '16-23
» 4-SEAT • 2881992 • \$539⁹⁹
POLARIS GENERAL XP 4 1000 '20-23
POLARIS GENERAL 4 1000 '17-23

XL FENDER FLARES

» FRONT & REAR • 2884220 • \$219⁹⁹
POLARIS GENERAL 1000/4 '16-23
Not compatible with Low Profile Rock Sliders
Standard on GENERAL XP models

HIGH CLEARANCE A-ARM GUARDS

» FRONT • 2884221 • \$219⁹⁹
POLARIS GENERAL XP 1000/4 '20-23
» REAR • 2884222 • \$219⁹⁹
POLARIS GENERAL XP 1000/4 '20-23

REAR SPORT BUMPER NOT SHOWN

» 2884345 • \$259⁹⁹
POLARIS GENERAL XP 1000/4 '20-23
POLARIS GENERAL 1000/4 '16-23

FRONT BUMPERS

Ⓐ **SPORT LOW PROFILE** TOP SELLER
» 2881094 • \$269⁹⁹
POLARIS GENERAL XP 1000/4 '20-23
POLARIS GENERAL 1000/4 '16-23

Ⓑ **SPORT UPPER**
» 2881525 • \$269⁹⁹
POLARIS GENERAL XP 1000/4 '20-23
POLARIS GENERAL 1000/4 '16-23
Requires Sport Low Profile Front Bumper
Not compatible with Front Hood Storage Rack (2889157)



EXPANSION ANCHOR MOUNTS

Tough expansion anchor mounts designed for Polaris GENERAL allow for quick install of rock sliders and bumpers without damaging the vehicle's frame.



STORAGE



BRING IT ALL. BRING IT ON.

From opposite sides of the globe, some of the most capable machines in the off-road world meet a trusted outdoor adventure brand to deliver industry-exclusive purpose-built bed racks and accessories to help Polaris GENERAL users have more fun and get more done. Increase storage capacity so you can go where you want with everything you need, organized to succeed.

REAR BED RACK



LOCK & RIDE

REAR BED RACK

- The ultimate modular load carrying solution
- Strong, lightweight aluminum construction tested in the harshest conditions
- Quickly adapt your vehicle from workday to weekend with a wide array of Rhino-Rack® attachments

» 2889443 • \$999⁹⁹

POLARIS GENERAL XP 1000/4 '20-23
POLARIS GENERAL 1000/4 '16-23

ATTACHMENTS



GUN MOUNTING BRACKET

- Bracket used to mount Kolpin Stronghold Gun Boots to Rhino-Rack® systems when paired with Auto-Latch Mount (2884106), sold separately

» 2889327 • \$54⁹⁹

POLARIS GENERAL XP 1000/4 '20-23
POLARIS GENERAL 1000/4 '16-23

See P. 18 for more hunt information



EYELET TIE-DOWNS

- Includes one set and hardware (straps not included) and attaches in multiple places on the platform to use as additional tie-down points
- Anti-corrosive galvanized steel for heavy-duty strength and long life

» 2889527 • \$52⁰⁰

POLARIS GENERAL XP 1000/4 '20-23
POLARIS GENERAL 1000/4 '16-23



MULTI-PURPOSE TOOL HOLDER

- Carry and protect tools, paddles and more during your ride
- Ratchet-locking mechanism for quick release with rubber inserts to secure accessories into place

» 2889528 • \$111⁰⁰

POLARIS GENERAL XP 1000/4 '20-23
POLARIS GENERAL 1000/4 '16-23



TRACTION BOARD MOUNT

- Strong, durable and easy to attach
- Traction board not included

» 2889530 • \$179⁰⁰

POLARIS GENERAL XP 1000/4 '20-23
POLARIS GENERAL 1000/4 '16-23



CARGO CORNER BRACKET

- Bring a Northstar cooler or toolbox while saving space inside your vehicle
- Unique anti-rotation nut for maximum cargo security

» 2889531 • \$129⁰⁰

POLARIS GENERAL XP 1000/4 '20-23
POLARIS GENERAL 1000/4 '16-23



200L LUGGAGE BAG

- Carry your bulky, light weight gear while on the road in this tear-resistant and weather-resistant canvas bag

» 2889881 • \$224⁰⁰

POLARIS GENERAL XP 1000/4 '20-23
POLARIS GENERAL 1000/4 '16-23



HIGH LIFTING JACK MOUNT

- Installs simply and quickly with durable brackets
- Rugged, non-corrosive powder-coated steel stands up to the harshest conditions

» 2889533 • \$112⁰⁰

POLARIS GENERAL XP 1000/4 '20-23
POLARIS GENERAL 1000/4 '16-23



STORAGE

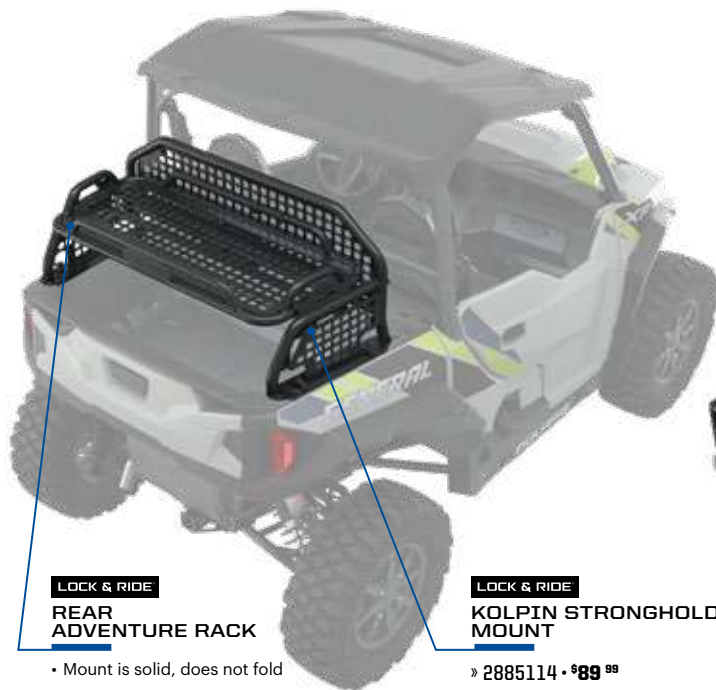

LOCK & RIDE
REAR ADVENTURE RACK

• Mount is solid, does not fold
» 2885113 • \$1,039⁹⁹
POLARIS GENERAL XP 1000/4 '20-23
POLARIS GENERAL 1000/4 '16-23
See P. 19 for more info

LOCK & RIDE
KOLPIN STRONGHOLD MOUNT

» 2885114 • \$89⁹⁹
POLARIS GENERAL XP 1000/4 '20-23
POLARIS GENERAL 1000/4 '16-23
See P. 19 for more info

CARGO BED MAT

» 2881933 • \$139⁹⁹
POLARIS GENERAL XP 1000/4 '20-23
POLARIS GENERAL 1000/4 '16-23

LOCK & RIDE
TIP-DOWN HEADACHE RACK

» 2882144 • \$384⁹⁹
POLARIS GENERAL XP 1000/4 '20-23
POLARIS GENERAL 1000/4 '16-23
Not compatible with Kolpin Stronghold Mount (2885114)

LOCK & RIDE
BED EXTENDER

» 2881547 • \$259⁹⁹
POLARIS GENERAL XP 1000/4 '20-23
POLARIS GENERAL 1000/4 '16-23
Not compatible with Kolpin Stronghold Mount (2885114)



BEHIND SEAT STORAGE BAG

» 2882164 • \$74⁹⁹
POLARIS GENERAL XP 1000/4 '20-23
POLARIS GENERAL 1000/4 '16-23



IN-DASH STORAGE BAG

» 2882165 • \$49⁹⁹
POLARIS GENERAL XP 1000/4 '20-23
POLARIS GENERAL 1000/4 '16-23



EASILY RECONFIGURE FOR ANY TASK OR ANY TRAIL

LOCK & RIDE
CARGO BOX

» 2881527 • \$349⁹⁹
POLARIS GENERAL XP 1000/4 '20-23
POLARIS GENERAL 1000/4 '16-23
Includes all mounting hardware for secure installation

LOCK & RIDE
D-RINGS **TOP SELLER**

» 2881545 • \$34⁹⁹
POLARIS GENERAL XP 1000/4 '20-23
POLARIS GENERAL 1000/4 '16-23



FIRE EXTINGUISHER HOLDER **[NOT SHOWN]**

» 2882158 • \$89⁹⁹
POLARIS GENERAL XP 1000/4 '20-23
POLARIS GENERAL 1000/4 '16-23
Fits most 3.25" fire extinguishers (not included)

CAB COMFORT



8-VENT HEATER AND DEFROST SYSTEM **TOP SELLER**

» 2881316 • \$1,199⁹⁹
POLARIS GENERAL XP 1000/4 '20-23
POLARIS GENERAL 1000/4 '16-23
Not Compatible with Rockford Fosgate® Stage 4 Audio Kits
Audio Bracket (2885112) required to install heater on vehicles with RIDE COMMAND and audio, sold separately



WINDSHIELD WIPER AND WASHER SYSTEM **TOP SELLER**

» 2881090 • \$589⁹⁹
POLARIS GENERAL XP 1000/4 '20-23
POLARIS GENERAL 1000/4 '16-23

SEE P. 08 FOR WINDSHIELDS



CONVEX REAR VIEW MIRROR

» 2881540 • \$109⁹⁹
POLARIS GENERAL XP 1000/4 '20-23
POLARIS GENERAL 1000/4 '16-23

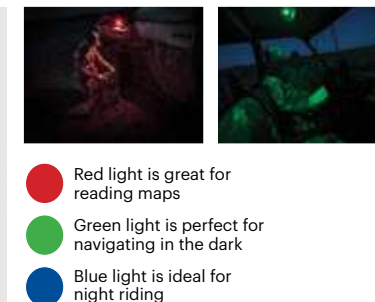

- Red light is great for reading maps
- Green light is perfect for navigating in the dark
- Blue light is ideal for night riding

MULTI-FUNCTION CAB LIGHT

- LED dome light provides white, red, green and blue lighting options
- Battery-operated, recharges when vehicle is on
- Remove to use as flashlight in and around vehicle

» 2884047 • \$124⁹⁹
POLARIS GENERAL XP 1000/4 '20-23
POLARIS GENERAL 1000/4 '19-23



FLOOR MATS

» 2881934 • \$129⁹⁹
POLARIS GENERAL XP 1000/4 '20-23
POLARIS GENERAL 1000/4 '16-23

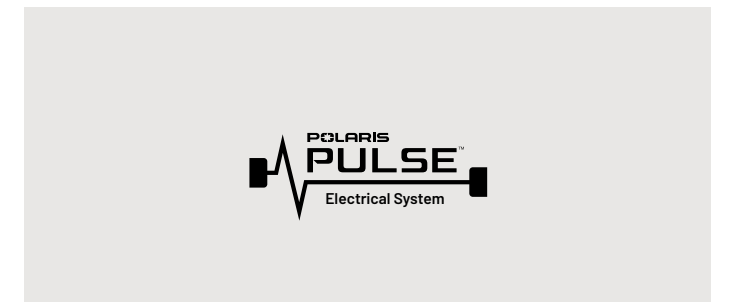

POLARIS PULSE LED LIGHT BAR HARNESS **TOP SELLER**

- Required to easily add electric components

» 2883785 • \$99⁹⁹
POLARIS GENERAL XP 1000/4 '20-23
POLARIS GENERAL 1000/4 '19-23

POLARIS ENGINEERED ADVANTAGES



ELECTRICAL INSTALLS MADE EASY WITH PLUG & PLAY



Look for **PULSE** to identify Polaris PULSE ready accessories.

- To install accessories, simply plug the harness into the Polaris PULSE hub
- No need to remove nuts and stack wire terminals like a three-post terminal setup
- By plugging in your accessories, a secure connection is guaranteed every time

HUNT

KOLPIN
OUTDOORS

PROTECTING YOUR ESSENTIAL GEAR SINCE 1943



STORAGE

LOCK & RIDE

REAR ADVENTURE RACK

- Take more gear with integrated MOLLE panels and Lock & Ride installation
- 30 or 60 Qt. Polaris coolers will still fit in bed with rack installed
- Compatible with (1) Kolpin Stronghold Mount

» 2885113 • \$1,039⁹⁹

POLARIS GENERAL XP 1000/4 '20-23
POLARIS GENERAL 1000/4 '16-23

LOCK & RIDE

KOLPIN STRONGHOLD MOUNT

- Kolpin Stronghold mount for attaching gun boots or other Kolpin Stronghold items to the Rear Adventure Rack

» 2885114 • \$89⁹⁹

POLARIS GENERAL XP 1000/4 '20-23
POLARIS GENERAL 1000/4 '16-23

KOLPIN STRONGHOLD CASES & MOUNT



KOLPIN STRONGHOLD GUN BOOT XL

- Includes zippered internal liner
- Lockable

» 2882036* • \$89⁹⁹

POLARIS GENERAL XP 1000/4 '20-23
POLARIS GENERAL 1000/4 '16-23



KOLPIN STRONGHOLD GUN BOOT L

» 2882426* • \$59⁹⁹

POLARIS GENERAL XP 1000/4 '20-23
POLARIS GENERAL 1000/4 '16-23



KOLPIN STRONGHOLD AUTO-LATCH MOUNT

» 2884106 • \$69⁹⁹

POLARIS GENERAL XP 1000/4 '20-23
POLARIS GENERAL 1000/4 '16-23



KOLPIN STRONGHOLD AUTO-LATCH DOUBLE GUN BOOT MOUNT

» 2883970 • \$184⁹⁹

POLARIS GENERAL XP 1000/4 '20-23
POLARIS GENERAL 1000/4 '16-23



GUN MOUNTING BRACKET

- Bracket used to mount Kolpin Stronghold Gun Boots to Rhino-Rack® systems when paired with Auto-Latch Mount (2884106), sold separately

» 2889327 • \$54⁹⁹

POLARIS GENERAL XP 1000/4 '20-23
POLARIS GENERAL 1000/4 '16-23

See P. 14 for more Rhino-Rack® products

RHINO-RACK® MOUNT

KOLPIN RHINO GRIPS IDEAL FOR BOWS & UNCASSED GUNS



LOCK & RIDE RHINO GRIP PRO

» 2884107 • \$89⁹⁹
POLARIS GENERAL XP 1000/4 '20-23
POLARIS GENERAL 1000/4 '16-23



LOCK & RIDE RHINO GRIP XLR - DOUBLES

» 2889166 • \$74⁹⁹
POLARIS GENERAL XP 1000/4 '20-23
POLARIS GENERAL 1000/4 '16-23



RHINO GRIP XLR REPLACEMENT RUBBER STRAPS (2)

» 2889204 • \$9⁹⁹
POLARIS GENERAL XP 1000/4 '20-23
POLARIS GENERAL 1000/4 '16-23



LOCK & RIDE RATCHETING RHINO GRIP

» 2881575 • \$69⁹⁹
POLARIS GENERAL XP 1000/4 '20-23
POLARIS GENERAL 1000/4 '16-23



RHINO GRIP PRO REPLACEMENT RUBBER STRAPS (2)

» 2884109 • \$9⁹⁹
POLARIS GENERAL XP 1000/4 '20-23
POLARIS GENERAL 1000/4 '16-23

ACCESSORIES

WINDSHIELDS & REAR PANELS

DOORS

ROOFS & PROTECTION

STORAGE, CAB COMFORT & HUNT

COOLERS

CONNECTED TECHNOLOGY & AUDIO

LIGHTING

WHEELS & TIRES

WINCHES, PULVS & TRACKS

19

18

KEEP IT
ICE COLD

GRIZZLY TESTED.
POLARIS APPROVED.



This cooler is IGBC-approved, meaning it withstands the power expended by a typical grizzly bear if it was trying to get inside.

Seriously, there are experts who know what a grizzly is capable of doing, and they certify our coolers can take it.



30, 60 & 105
QUART FEATURES



ComfortCarry
Handles



TravelLock
System



EasyOut
Drain System



NoSlip
Rubber Feet



PolarWall
Insulation



IceLock
Seal

POLARIS NORTHSTAR COOLERS CAN SURVIVE JUST ABOUT ANYTHING - FROM EXTREME HEAT TO A NASTY TUMBLE OFF A VEHICLE.



105 QUART

» GRAPHITE • 2883426 • \$419⁹⁹
» DESERT • 2883392 • \$419⁹⁹



60 QUART

» GRAPHITE • 2883425 • \$329⁹⁹
» DESERT • 2881259 • \$329⁹⁹



30 QUART

» GRAPHITE • 2883424 • \$259⁹⁹
» DESERT • 2881315 • \$259⁹⁹



15 QUART

» GRAPHITE • 2883968 • \$199⁹⁹



20 QUART SOFT-SIDED COOLER

» GRAPHITE • 2889285 • \$189⁹⁹

HOLDS ICE
30+
HOURS
LONGER
THAN YETI^{®*}

*YETI is a registered trademark of YETI COOLERS, LLC

ESSENTIAL ACCESSORIES SO YOUR COOLER WORKS AS HARD AS YOU DO

COOLER ACCESSORIES	105 QUART	60 QUART	30 QUART	DON'T FORGET THESE ACCESSORIES		
<p>WIRE BASKET</p>	2883648 • \$44 ⁹⁹	2882185 • \$30 ⁹⁹	2882438 • \$25 ⁹⁹	<p>TUMBLER</p> <p>» 20 OZ • 2883393 • \$24⁹⁹</p>	<p>LOCK & RIDE QUICKSTRAP</p> <p>» 2882187 • \$44⁹⁹ ALL COOLERS AND POLARIS GENERAL CARGO BOXES</p>	<p>BOTTLE OPENER</p> <p>» 2882183 • \$14⁹⁹ ALL COOLERS</p>
<p>DIVIDERS Doubles as cutting board</p>	2883468 • \$34 ⁹⁹ COMES WITH ONE DIVIDER 1 way to partition	2882184 • \$44 ⁹⁹ COMES WITH TWO DIVIDERS 2 ways to partition	2882186 • \$24 ⁹⁹ COMES WITH ONE DIVIDER 1 way to partition			
<p>SEAT CUSHION</p>	NOT AVAILABLE	2882179 • \$89 ⁹⁹	2882507 • \$69 ⁹⁹			
<p>WHEELS</p>	2883967 • \$94 ⁹⁹	2882180 • \$99 ⁹⁹	NOT AVAILABLE			

CONNECTED TECHNOLOGY



POLARIS RIDE COMMAND



ENHANCE YOUR RIDE WITH RIDE COMMAND

PLAN YOUR RIDE

Plan an epic ride with stops along the way, customize and adjust your path to maximize your route or follow turn-by-turn directions. You can even share your planned route with friends.

FOLLOW THE GROUP

With Group Ride, you can ride at your own speed and keep fellow riders in sight on your map screen, even if you get split up. Because rides are meant to be shared.

DISCOVER NEW TRAILS

With over 1,000,000 miles of trails available offline, you'll have the confidence to explore further, whether you have cellular coverage or not.

JOIN THE COMMUNITY

Discover new destinations and get inspired by checking out other rides in your area. You can even share your own rides for others to enjoy.

TRAIL TECH



VOYAGER PRO

ADD ANY VEHICLE TO YOUR POLARIS GROUP RIDES

The Trail Tech Voyager Pro GPS seamlessly connects with 2020-2023 Polaris 7" Displays. Join the group ride.

THE CONNECTED RIDER'S GPS

Featuring Polaris Group Ride compatibility, custom maps, Bluetooth®, a 4" color touchscreen and full vehicle integration with gauges.

Model-specific kits available for all UTV, ATV, snow and motorcycle brands.

7" DISPLAY POWERED BY RIDE COMMAND*

- Bright, 7" touchscreen visible in all conditions
- **GPS Navigation & Pre-Loaded Maps**
Available offline on the in-dash display so you always know where you are.
- **Route Planning**
Add points of interest and waypoints to make the most of your off-road adventure.
- **Group Ride**
"Follow the Leader" lets you set and follow the group leader on your display. Group Ride Messaging, lets you send messages to your group with or without a cellular signal.

- **Camera Integration**
Navigate with full view of your surroundings. Use the integrated rear camera to see others behind you while riding.
- **Personalized Audio Experience**
Seamlessly pair your display via Bluetooth** to wirelessly stream music and stay connected with call and text alerts.
- **Configurable Gauges**
Customize your ride experience with elevation, travel direction, fuel level and more to create relevant screens for you.

» 2884072 • \$1,594⁹⁹
POLARIS GENERAL XP 1000/4 '20-23
POLARIS GENERAL 1000/4 '19-23



7" DISPLAY MOUNT KIT

- Mount RIDE COMMAND seamlessly into the dash for perfect fit and finish
 - Comes with required wiring harnesses and accessory components
 - Includes front and rear camera, V2V and GPS antenna
- » 2889338 • \$529⁹⁹
POLARIS GENERAL XP 1000/4 '20-23
POLARIS GENERAL 1000/4 '20-23
WHEN REPLACING FACTORY IN-DASH AUDIO: EITHER AMP (2414533) AND RELOCATION KIT (2885112), BOTH REQUIRED SOLD SEPARATELY -OR- STAGE 3 RIDE COMMAND AUDIO KIT & REAR SPEAKERS (2885163), SOLD SEPARATELY, ARE REQUIRED



AUDIO BRACKET

- Used to mount audio amplifier for front and rear speakers when subwoofer is removed
 - Required to install a heater on a vehicle with RIDE COMMAND and audio
- » 2885112 • \$64⁹⁹
POLARIS GENERAL XP 1000/4 '20-23
POLARIS GENERAL 1000/4 '20-23

VOYAGER PRO KIT, UTV

- Bright, 4" touchscreen visible in all conditions
- **Pre-Loaded Base Maps**
The map screen is enabled with base maps, topography lines, hill shading and select trails. Record or load GPS trails/riding areas and transfer to a PC.
- **Buddy Tracking**
Track up to 20 group members no matter what type of vehicle they are riding.
- **Bluetooth® Enabled**
Bluetooth® enabled for intercom, phone and media controls. Play songs from your phone or MicroSD card using a Bluetooth® headset, speaker or intercom. Two phones and two headsets can be connected at the same time.

» 922-125 • \$649⁹⁵
AVAILABLE AT YOUR LOCAL DEALER OR ONLINE AT TRAILTECH.NET



LEARN MORE AND DOWNLOAD AT
RIDECOMMAND.POLARIS.COM



LEARN MORE AT
TRAILTECH.NET



*Due to ongoing supply chain issues, there may be delayed or limited availability of this product as an accessory add-on.

AUDIO



PLUG AND PLAY



ELEMENT READY™



NO LOSS OF CARGO SPACE



BLUETOOTH™ CAPABLE



An industry first. A true factory installed integrated off-road audio system. Rockford Fosgate® partnered with Polaris to purpose build the highest performing system specifically for the GENERAL platform. Tuned and rider-centric to create a class leading audio experience that is second to none.



TOP SELLER
STAGE 1 AUDIO KIT

PMX-P2 HEAD UNIT & FRONT COAXIAL SPEAKERS & ANTENNA

- 2.7" full color display with AM/FM/WB tuner, Pandora™ Control and Bluetooth™ Connectivity
- 50 Watt 6.5" front coaxial speakers with enclosures and grilles

» 2884282 • \$999⁹⁹

POLARIS GENERAL XP 1000/4 '20-23
POLARIS GENERAL 1000/4 '20-23



STAGE 3 PMX AUDIO KIT + REAR SPEAKERS

REAR COAXIAL SPEAKERS & AMP

- 2, 50 Watt 6.5" rear coaxial speakers with enclosures and grilles
- 400 Watt 4-channel full range amplifier
- IP67 Rating delivering water resistance and dust protection

» 2885162 • \$899⁹⁹

POLARIS GENERAL XP 1000/4 '20-23
POLARIS GENERAL 1000/4 '16-23



TOP SELLER
STAGE 3 RIDE COMMAND AUDIO KIT + REAR SPEAKERS

FRONT & REAR COAXIAL SPEAKERS, ANTENNA & AMP

- 2, 50 Watt 6.5" front and rear coaxial speakers with enclosures and grilles
- 400 Watt 4-channel full range amplifier
- IP67 Rating delivering water resistance and dust protection

» 2885163 • \$1,099⁹⁹

POLARIS GENERAL XP 1000/4 '20-23
POLARIS GENERAL 1000/4 '16-23
REQUIRES 7" DISPLAY WITH RIDE COMMAND (2884072) & 7" DISPLAY MOUNT KIT (2884283), BOTH SOLD SEPARATELY



STAGE 4 UPGRADE

POWERED SUBWOOFER

- Compatible with Stage 1 and Stage 2 PMX-P2 Audio Kits
- 400 Watt 10" subwoofer
- Compatible with Stage 1 and Stage 3 Audio Kits

» 2889306 • \$649⁹⁹

POLARIS GENERAL XP 1000/4 '20-23
POLARIS GENERAL 1000/4 '16-23
NOT COMPATIBLE WITH HEATER KIT (2881316)
REQUIRES RIDE COMMAND. FOR USE WITH PMX, SUBSTITUTE FOR 2889053

BUILD YOUR SOUND

HEAD UNIT:	PMX-P2		RIDE COMMAND
AUDIO:	STAGE 1 AUDIO KIT	STAGE 3 + 4 UPGRADES	STAGE 3 RIDE COMMAND AUDIO KIT
MODEL FITMENT:			
XP	STAGE 1 AUDIO KIT WITH PMX-P2 HEAD UNIT INSTALLED	STAGE 3 + REAR SPEAKERS UPGRADE REAR SPEAKERS, AMP + AUDIO BRACKET 2885162 • \$899 ⁹⁹	RIDE COMMAND + STAGE 3 AUDIO SYSTEM BY ROCKFORD FOSGATE™ MODEL INSTALLED
DELUXE			TO ADD 8-VENT HEATER & DEFROST SYSTEM (2881316), SUBWOOFER MUST BE REMOVED AND AMP RELOCATION BRACKET (2885112) MUST BE INSTALLED
PREMIUM		OPTIONAL SUBWOOFER	
SPORT	STAGE 1 AUDIO KIT PMX HEAD UNIT + FRONT COAXIAL SPEAKERS + ANTENNA 2884282 • \$999 ⁹⁹	STAGE 4 UPGRADE SUBWOOFER 2889306 • \$649 ⁹⁹ <small>NOT COMPATIBLE WITH 8-VENT HEATER & DEFROST SYSTEM (2881316)</small> <small>REQUIRES RIDE COMMAND. FOR USE WITH PMX, SUBSTITUTE FOR 2889053</small>	7" DISPLAY WITH RIDE COMMAND* 2884072 • \$1,594 ⁹⁹ + 7" DISPLAY MOUNT KIT 2889338 • \$529 ⁹⁹ <small>2020-2023 MODELS</small> + STAGE 3 UPGRADE REAR SPEAKERS, AMP + AUDIO BRACKET 2885163 • \$1,099 ⁹⁹ + STAGE 4 UPGRADE SUBWOOFER 2889306 • \$649 ⁹⁹ <small>NOT COMPATIBLE WITH 8-VENT HEATER & DEFROST SYSTEM (2881316)</small>

*Due to ongoing supply chain issues, there may be delayed or limited availability of this product as an accessory add-on.

ACCESSORIES

WINDSHIELDS & REAR PANELS

DOORS

ROOFS & PROTECTION

STORAGE, CAB COMFORT & HUNT

COOLERS

CONNECTED TECHNOLOGY & AUDIO

LIGHTING

WHEELS & TIRES

WINCHES, PULVS & TRACKS



POLARIS ENGINEERED ADVANTAGES

MOUNTS PERFECTLY
Designed for your Polaris Engineered bumper, roof or other mounting point

MAX PERFORMANCE
Validated to work as hard as your machine does

DOESN'T OVERTAX
Trust it to work when you need it to

PRO ARMOR



ADVANCED TECH

RIGID® lights are driven by Aluminum PCB Smart Boards™, 6063-T5 aircraft aluminum extruded housings and Tiger Drylac® UV protection polyester powdercoating.

EXCLUSIVE OPTICS

RIGID® invests heavily in optical science and has patented multiple optics and optics systems, maximizing light output and efficiency.

RIGID® LIMITED LIFETIME WARRANTY

If you own a RIGID® light and it breaks, we will replace or repair it for life.*

RUGGED CONSTRUCTION

Pro Armor lights are designed to be big and beefy with an aggressive style all their own, and housed in IP67 marine-grade rated UV polyester powdercoating.

MASSIVELY BRIGHT

Pro Armor builds bright lights designed for any riding experience. All that power is directed through heat dissipating aluminum for streamlined heat management.

LIGHT BAR TYPES



SR-SERIES PRO

Sleek, powerful, low-profile (under 2" tall). Lights extreme distances with low energy usage.
Available in 10" & 32"



D-SERIES PRO

Compact to fit almost anywhere with high output and low energy usage.
Available in Driving, Flood & Spot



DUAL-ROW LED

The most spread and farthest illumination downrange. Easy to mount.
Available in 11" & 31"



SINGLE-ROW LED

Powerful, compact, low-profile light bars with sleek look.
Available in 11", 20", 33" & 40"



CUBE LED

Small size allows mounting in strategic locations for added lighting.
Available in Spot

LIGHT BAR OPTIONS

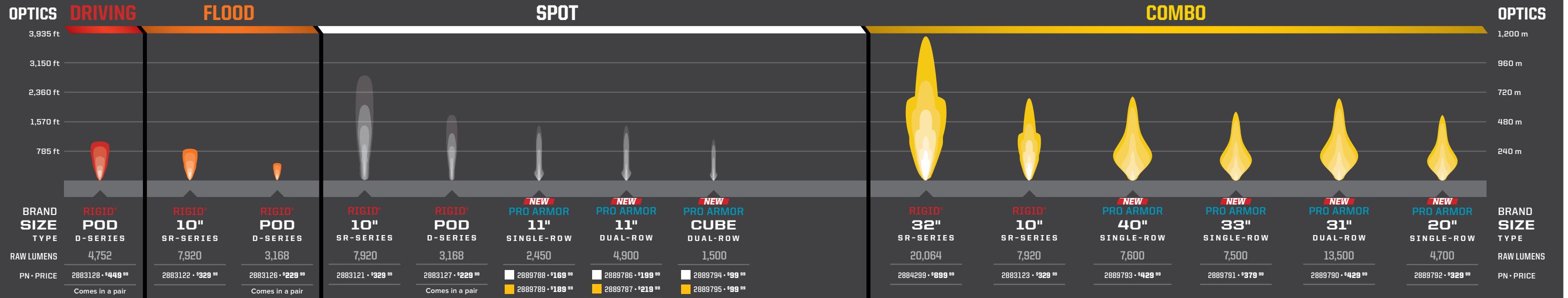

SHOP & VERIFY VEHICLE FITMENT AT [POLARIS.COM/ShopGENERAL](https://Polaris.com/ShopGENERAL)

BUILD YOUR VISION

Consider the optics, angle & how you will use your vehicle to choose the right light or set of lights.

OPTICS LIGHT ANGLE	ACCENT	DRIVING (45°)	FLOOD (25°)	SPOT (10°)	COMBO (25°/10°)
DRIVING SPEED	All	Slow	Medium	Fast	Medium to fast
BEAM	Diffused glow	Extra-wide	Wide/shorter	Concentrated/long	Inner spot & outer flood
RECOMMENDED MOUNTING	Low/wheel well	All points	Low &/or rear	High points	All points
TERRAIN & RIDING STYLE	Added style & personalization in any terrain	All riding & utility	Wide-open terrain or trails & utility	Trail & tight conditions	All riding & utility

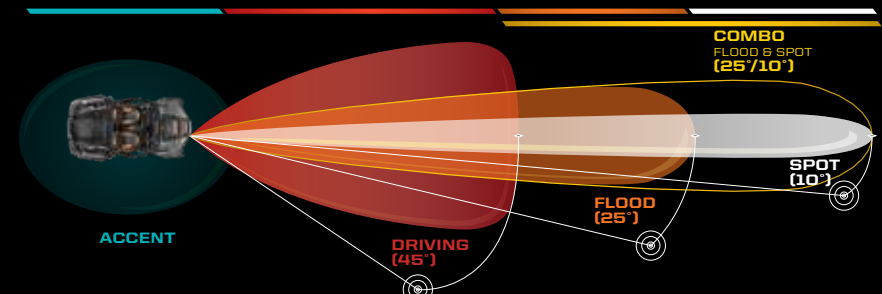

COMPARE LIGHTS IN A REAL WORLD SETTING AT [POLARIS.COM/LIGHTING](https://Polaris.com/Lighting)

ADD A HARNESS TO MOUNT YOUR LIGHTS

MODEL	LIGHT BAR SET-UPS		
	1 LIGHT IN 1 LOCATION ON 1 SWITCH	2 LIGHTS IN 2 LOCATIONS ON 1 SWITCH	2 LIGHTS IN 2 LOCATIONS ON 2 SWITCHES
2019-2023 ALL MODELS	TOP SELLER POLARIS PULSE LED LIGHT BAR HARNESS 2883785 • *99 ⁹⁹	TOP SELLER POLARIS PULSE LED LIGHT BAR HARNESS 2883785 • *99 ⁹⁹ Y-HARNESS 2879860 • *19 ⁹⁹	TOP SELLER POLARIS PULSE LED LIGHT BAR HARNESS (x2) 2883785 • *99 ⁹⁹

▲ No battery connection cables required on any model/model year Polaris GENERAL 1000.

All RIGID® and Pro Armor lights are Polaris PULSE ready.

* If RIGID® determines, in its sole discretion, that your product is defective in material or workmanship, RIGID® will honor your warranty claim. In some cases the product will be replaced, depending on the specific timeframe of the purchase. If the product is repaired, all parts, labor, and return shipping may be covered by RIGID®.

ACCESSORIES

WINDSHIELDS & REAR PANELS

DOORS

ROOFS & PROTECTION

STORAGE, CAB COMFORT & HUNT

COOLERS

CONNECTED TECHNOLOGY & AUDIO

LIGHTING

WHEELS & TIRES

WINCHES, PULWS & TRACKS

KNOW YOUR TERRAIN



- Tread patterns optimized for extreme traction
- Ideal for both hard pack and loose trail



- Flexible "grippy" tread
- Aggressive side bite



- Provides traction and durability
- Built to perform in hard sand, jagged rocks or any other extreme terrain



- Extra deep treads
- Self-cleaning lugs



- Paddles provide traction and durability in soft sand
- Built to float on top of sand



- Triple-belted sidewalls to resist puncture
- Purpose-built, long lasting tread patterns



- Handles extreme cold
- Holds shape and provides traction

SUPERIOR PERFORMANCE & DURABILITY

WAYS TO SHOP WHEELS & TIRES



LIFELONG PERFORMANCE

- Every tire is designed and constructed with longevity in mind
- 3,000+ mile rated (4,828 kilometers)

PREMIUM PROTECTION

- Pro Armor makes tires with extra protection exactly where it's needed most — the sidewall
- Triple-belted sidewalls keep your tires more resistant so you can keep going

TOUGH TIRES

- Higher ply ratings mean added protection
- Pro Armor builds 8 or 10-ply rated tires for higher puncture-resistance



KNOW YOUR TIRES

DIMENSIONS			TREAD DEPTH	TIRE WEIGHT	PLY RATING	SIDEWALL BELTS	LOAD RATING
TIRE HEIGHT	TIRE WIDTH	WHEEL DIAMETER					
32" x 9"	R15	FRONT/REAR	30 mm	41 lbs	10	3	1,320 lbs
Part Number • Price							
USAGE Where can you use the tire			TREAD DEPTH Deeper treads have more grip in all conditions	TIRE WEIGHT A lighter tire makes for improved vehicle performance	PLY RATING Indicates tire puncture-resistance	SIDEWALL BELTS Increase your resistance to sidewall punctures	LOAD RATING How much weight can the tire handle

TIRES BY SIZE

26"	27"	28"	29"	30"
ATTACK	HARVESTER	ATTACK 2.0	DUAL-THREAT	ATTACK 2.0
DUAL-THREAT	MUD XC	CRAWLER XG	HD-K	CRAWLER AT
HARVESTER		CRAWLER XR	MUD XC	CRAWLER XG
XD-K		HARVESTER		CRAWLER XR
				HARVESTER
				MUD XC

TIRES BY TERRAIN

TRAIL	ROCK	DESERT	MUD	UTILITY	SNOW
ATTACK	ATTACK 2.0	ATTACK	MUD XC	HARVESTER	ATTACK
ATTACK 2.0	CRAWLER AT	ATTACK 2.0		HD-K	ATTACK 2.0
CRAWLER AT	CRAWLER XG	CRAWLER AT		XD-K	HARVESTER
CRAWLER XG	CRAWLER XR	CRAWLER XG			HD-K
CRAWLER XR	DUAL-THREAT	CRAWLER XR			XD-K
DUAL-THREAT		DUAL-THREAT			
HARVESTER					
HD-K					
MUD XC					
XD-K					

WHEELS BY SIZE

14"	15"
40-SERIES (14 TIRE OPTIONS)	50-SERIES (8 TIRE OPTIONS)
4201	5201
4202	5202
4203 BEADLOCK	5203 BEADLOCK
4204	5301 BEADLOCK
4205	
4301 BEADLOCK	
HD DUAL BEADLOCK	

KNOW YOUR WHEELS

STEP 1: SELECT YOUR SERIES

4 = 40-SERIES 5 = 50-SERIES

STEP 2: CHOOSE YOUR LOAD RATING

1 = <800 LBS 2 = 801 - 1,300 LBS 3 = 1,301 - 1,600+ LBS

STEP 3: PICK YOUR STYLE

OFFSET / BEADLOCK / COLOR

INCREASE OFFSET FROM STOCK = NARROWER STANCE
DECREASE OFFSET FROM STOCK = WIDER STANCE

TIRES



PRO ARMOR CRAWLER XR

- Premium grip for all terrains, from the trail to the rocks
- Square block profile for even surface contact
- A tougher durometer than the XG to take on the toughest the trail has to offer

		TREAD DEPTH	TIRE WEIGHT	PLY RATING	SIDEWALL BELTS	LOAD RATING
14"	FRONT/REAR	16 mm	28" x 10" R14 5415536 • \$209 ⁹⁹	8	3	32 lbs
			30" x 10" R15 5418254 • \$244 ⁹⁹			37 lbs
15"						1,140 lbs
						1,280 lbs



WHAT CRAWLER ARE YOU?

XR

SINGLE DUROMETER

- Smaller lug height, added rigidity and lateral stability when cornering
- Unique lug design excels in hard pack, fast terrain



PRO ARMOR ATTACK 2.0

- Engineered for excellent hard pack performance
- Dual-compound technology and radial construction offer performance in all terrains
- Tight thread pattern for a quieter ride

		TREAD DEPTH	TIRE WEIGHT	PLY RATING	SIDEWALL BELTS	LOAD RATING
15"	FRONT/REAR	25 mm	28" x 10" R15 5416344 • \$219 ⁹⁹	10	3	32 lbs
			30" x 10" R15 5416345 • \$249 ⁹⁹			38 lbs
						1,110 lbs
						1,235 lbs



TIGHTER TREAD PATTERN -
Better traction in hard pack

DUAL-DUROMETER LUG -
Increased grip & traction in rough terrain, smoother ride in all terrain

10-PLY RATED -
Increased durability

LARGER 28" & 30" SIZE OFFERING -
More ground clearance & trail traction



PRO ARMOR CRAWLER XG

- Built to crawl over all obstacles, both large and small
- A soft, sticky compound makes this tire ideal for both rock crawling and desert running
- 8-ply, triple-belted ballistic sidewalls resist punctures

		TREAD DEPTH	TIRE WEIGHT	PLY RATING	SIDEWALL BELTS	LOAD RATING
14"	FRONT/REAR	20 mm	30" x 10" R14 5415616 • \$239 ⁹⁹	8	3	38 lbs
			28" x 10" R15 5416346 • \$219 ⁹⁹			33 lbs
15"						1,280 lbs
15"						1,100 lbs
						1,390 lbs



XG

DUAL-DUROMETER

- Taller lug height and dual-durometer construction
- Perfect balance between high-speed performance, durability and flex in order to grip slick rock



PRO ARMOR ATTACK

- The best all-purpose tire for all-season traction in any terrain
- Unique, full-face tread design
- Harder durometer lugs promote extended wear, increasing tire life
- Wider spaced lugs provide more grip in softer terrain

		TREAD DEPTH	TIRE WEIGHT	PLY RATING	SIDEWALL BELTS	LOAD RATING
14"	FRONT	23 mm	26" x 9" R14 5415613 • \$154 ⁹⁹	8	3	28 lbs
			26" x 11" R14 5415614 • \$169 ⁹⁹			32 lbs
						910 lbs
						1,320 lbs



PRO ARMOR CRAWLER AT

- Directional tread for optimum performance
- Greater lug separation for easy mud clean out
- 8-ply, triple-belted ballistic sidewalls resist punctures

		TREAD DEPTH	TIRE WEIGHT	PLY RATING	SIDEWALL BELTS	LOAD RATING
15"	FRONT/REAR	18 mm	30" x 10" R15 5417534 • \$239 ⁹⁹	8	3	36 lbs
						1,280 lbs



AT

DIRECTIONAL LUG PATTERN

- The same taller lug height as Crawler XG, providing more grip and better traction
- Wider lug spacing for excellent mud clean-out



ACCESSORIES

WINDSHIELDS & REAR PANELS

DOORS

ROOFS & PROTECTION

STORAGE CAB COMFORT & HUNT

COOLERS

CONNECTED TECHNOLOGY & AUDIO

LIGHTING

WHEELS & TIRES

WINCHES, PULVS & TRACKS

TIRES



PRO ARMOR DUAL-THREAT

- Dual-compound technology and radial construction offer performance in all terrains
- Softer durometer rubber on outer edge for overall superior grip and feel
- Harder durometer rubber in the middle for increased traction during acceleration and longer tread life

	TREAD DEPTH	TIRE WEIGHT	PLY RATING	SIDEWALL BELTS	LOAD RATING
14" 26" x 9" R14 5416340 • \$179 ⁹⁹	16 mm	27 lbs	10	3	910 lbs
14" 26" x 11" R14 5416341 • \$189 ⁹⁹		30 lbs			1,110 lbs
14" 29" x 9" R14 5416342 • \$219 ⁹⁹		30 lbs			1,110 lbs
14" 29" x 11" R14 5416343 • \$229 ⁹⁹		35 lbs			1,320 lbs



FRONT/REAR

WHEEL SIZE

14"

DUAL-COMPOUND
= MORE GRIP +
LONGER LIFE

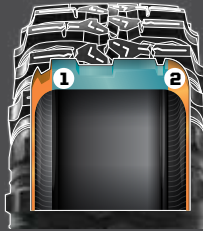

- 1 Firmer Durometer Rubber = Longer Life
- 2 Softer Durometer Rubber = More Grip



PRO ARMOR HARVESTER

- All-around work horse with tread life of 5,000 miles / 8047 km
- Tread pattern designed to withstand anything from the farmyard to the pastures and the trail
- With 10-ply, it can carry the load day in and day out

	TREAD DEPTH	TIRE WEIGHT	PLY RATING	SIDEWALL BELTS	LOAD RATING
12" 26" x 8" R12 5416396 • \$189 ⁹⁹	16 mm	24 lbs	10	3	855 lbs
12" 26" x 10" R12 5415966 • \$199 ⁹⁹		32 lbs			1,355 lbs
14" 27" x 10" R14 5415965 • \$199 ⁹⁹		32 lbs			1,320 lbs
14" 28" x 10" R14 5416347 • \$219 ⁹⁹		34 lbs			1,390 lbs
15" 30" x 10" R15 5417529 • \$239 ⁹⁹		37 lbs			1,320 lbs



FRONT/REAR

WHEEL SIZE

12" 14" 15"



PRO ARMOR MUD XC

- Designed as the perfect mud-trail crossover for a smooth ride on the trail and aggressive traction in the mud
- Dual-compound technology with harder durometer lugs promote extended wear, increasing tire life
- 10-ply construction means added protection in the toughest terrain

	TREAD DEPTH	TIRE WEIGHT	PLY RATING	SIDEWALL BELTS	LOAD RATING
14" 27" x 9" R14 5416947 • \$189 ⁹⁹	30 mm	30 lbs	10	3	1,170 lbs
14" 27" x 11" R14 5416948 • \$209 ⁹⁹		32 lbs			1,320 lbs
14" 29" x 10" R14 5416946 • \$219 ⁹⁹		39 lbs			1,390 lbs
15" 30" x 10" R15 5418253 • \$229 ⁹⁹		37 lbs			1,280 lbs



FRONT/REAR

WHEEL SIZE

14" 15"



PRO ARMOR XD-K

- 26" Aramid fiber-belted tire to tackle any terrain
- Unique full-face tread design
- Harder durometer lugs promotes extended wear, increasing tire life

	TREAD DEPTH	TIRE WEIGHT	PLY RATING	SIDEWALL BELTS	LOAD RATING
12" 26" x 9" R12 5415756 • \$227 ⁹⁹	31.7 mm	28 lbs	10	3/1 Aramid	855 lbs
12" 26" x 11" R12 5415757 • \$269 ⁹⁹		32 lbs			1,100 lbs



FRONT/REAR

WHEEL SIZE

12"

PICKING THE RIGHT UTILITY TIRE

UTILITY FEATURE	HARVESTER	XD-K	HD-K
5,000 Mile / 8,047 Kilometer Rated Long life and performance	X		
10-Ply Rated Higher ply ratings means added protection	X	X	X
Heavy Duty Tread Aggressive tread pattern for all day work on farms or ranches	X	X	X
Turf-Friendly Easy on grass and farm yard	X		
Aramid Fiber Belt 5x times stronger than steel and lighter		X	X
Size Options For exactly how you want to use your machine	26", 27", 28", 30"	26"	29"



PRO ARMOR HD-K

- Designed to provide a smooth ride and aggressive traction in all riding terrains
- Triple-belted sidewall provides extreme protection and extends the tire life
- Quad belt tread core offers superior protection and longer tread life

	TREAD DEPTH	TIRE WEIGHT	PLY RATING	SIDEWALL BELTS	LOAD RATING
14" 29" x 10" R14 5417507 • \$346 ⁹⁹	31.75 mm	40 lbs	10	3/1 Aramid	1,320 lbs



FRONT/REAR

WHEEL SIZE

14"

ACCESSORIES

WINDSHIELDS & REAR PANELS

DOORS

ROOFS & PROTECTION

STORAGE, CAB COMFORT & HUNT

COOLERS

CONNECTED TECHNOLOGY & AUDIO

LIGHTING

WHEELS & TIRES

WINCHES, PULVS & TRACKS

WHEELS



14"

40-SERIES

A 4201 ○

FRONT WEIGHT:	13 lbs	LOAD RATING:	900 lbs	OFFSET:	+9
REAR WEIGHT:	14 lbs	LOAD RATING:	1,300 lbs	OFFSET:	+9
ACCENT:	FRONT 14" × 7"		1522956-266		\$154 ⁹⁹
	REAR 14" × 8"		1522957-266		\$169 ⁹⁹
MATTE BLACK:	FRONT 14" × 7"		1522956-458		\$129 ⁹⁹
	REAR 14" × 8"		1522957-458		\$139 ⁹⁹

B 4202 ○

FRONT WEIGHT:	12.75 lbs	LOAD RATING:	900 lbs	OFFSET:	+4
REAR WEIGHT:	13.5 lbs	LOAD RATING:	1,300 lbs	OFFSET:	-9
ACCENT:	FRONT 14" × 7"		1522544-266		\$154 ⁹⁹
	REAR 14" × 8"		1522545-266		\$169 ⁹⁹
MATTE BLACK:	FRONT 14" × 7"		1522544-458		\$129 ⁹⁹
	REAR 14" × 8"		1522545-458		\$139 ⁹⁹

C 4203 BEADLOCK ○ ○

FRONT WEIGHT:	13 lbs	LOAD RATING:	900 lbs	OFFSET:	+4
REAR WEIGHT:	14.5 lbs	LOAD RATING:	1,300 lbs	OFFSET:	-9
MATTE BLACK:	FRONT 14" × 7"		1522238-458		\$229 ⁹⁹
	REAR 14" × 8"		1522239-458		\$229 ⁹⁹

D 4204 ○

FRONT WEIGHT:	13 lbs	LOAD RATING:	900 lbs	OFFSET:	+4
REAR WEIGHT:	14 lbs	LOAD RATING:	1,300 lbs	OFFSET:	-9
ACCENT:	FRONT 14" × 7"		1522546-266		\$154 ⁹⁹
	REAR 14" × 8"		1522547-266		\$154 ⁹⁹
MATTE BLACK:	FRONT 14" × 7"		1522546-458		\$129 ⁹⁹
	REAR 14" × 8"		1522547-458		\$129 ⁹⁹

E 4205 ○

FRONT WEIGHT:	10.5 lbs	LOAD RATING:	900 lbs	OFFSET:	+4
REAR WEIGHT:	12.5 lbs	LOAD RATING:	1,300 lbs	OFFSET:	-9
MATTE BLACK:	FRONT 14" × 7"		1521507-521		\$119 ⁹⁹
	REAR 14" × 8"		1521508-521		\$129 ⁹⁹
LUSTER:	FRONT 14" × 7"		1521507-410		\$154 ⁹⁹
	REAR 14" × 8"		1521508-410		\$159 ⁹⁹

F 4301 BEADLOCK

FRONT/REAR WEIGHT:	16 lbs	LOAD RATING:	1,600 lbs	OFFSET:	+38
ACCENT:	FRONT/REAR 14" × 7"		1523284		\$219 ⁹⁹
MATTE BLACK:	FRONT/REAR 14" × 7"		1523283		\$209 ⁹⁹

G HD DUAL BEADLOCK

FRONT/REAR WEIGHT:	40 lbs	LOAD RATING:	1,600 lbs	OFFSET:	+38
MATTE BLACK:	FRONT/REAR 14" × 7"		1524022-458		\$283 ⁹⁹

15"

50-SERIES

H 5201

FRONT/REAR WEIGHT:	17.1 lbs	LOAD RATING:	1,300 lbs	OFFSET:	+4
ACCENT:	FRONT/REAR 15" × 7"		1523184-266		\$139 ⁹⁹
MATTE BLACK:	FRONT/REAR 15" × 7"		1523184-458		\$119 ⁹⁹

I 5202

FRONT/REAR WEIGHT:	17.8 lbs	LOAD RATING:	1,300 lbs	OFFSET:	+4
ACCENT:	FRONT/REAR 15" × 7"		1523102-266		\$139 ⁹⁹
MATTE BLACK:	FRONT/REAR 15" × 7"		1523102-458		\$119 ⁹⁹

J 5203 BEADLOCK ○ ○

FRONT/REAR WEIGHT:	16 lbs	LOAD RATING:	1,300 lbs	OFFSET:	+38
MATTE BLACK:	FRONT/REAR 15" × 7"		1522435-458		\$249 ⁹⁹

K 5301 BEADLOCK

FRONT/REAR WEIGHT:	17 lbs	LOAD RATING:	1,600 lbs	OFFSET:	+38
ACCENT:	FRONT/REAR 15" × 7"		1523282		\$239 ⁹⁹
MATTE BLACK:	FRONT/REAR 15" × 7"		1523266		\$219 ⁹⁹

- LUG NUTS REQUIRED
- BEADLOCK SOLD SEPARATELY

BEADLOCK RINGS

14" FORGED BEADLOCK RINGS

A Machined Fits 4203 Beadlock & HD Dual Beadlock	1522244-266 \$124 ⁹⁹
C Matte Black - Replacement Fits 5301 Beadlock & HD Dual Beadlock	1523146-458 \$69 ⁹⁹
15" FORGED BEADLOCK RINGS	
E Matte Black - Replacement Fits 5203 Beadlock	1523147-458 \$64 ⁹⁹



KNOW YOUR WHEELS

STEP 1: SELECT YOUR SERIES

4 = 40-SERIES 5 = 50-SERIES

STEP 2: CHOOSE YOUR LOAD RATING

1 = <800 LBS 2 = 801 - 1,300 LBS 3 = 1,301 - 1,600+ LBS

STEP 3: PICK YOUR STYLE

OFFSET / BEADLOCK / COLOR

INCREASE OFFSET FROM STOCK = NARROWER STANCE
DECREASE OFFSET FROM STOCK = WIDER STANCE

KNOW YOUR TERRAIN



- Tread patterns optimized for extreme traction
- Ideal for both hard pack and loose trail



- Extra deep treads
- Self-cleaning lugs



- Triple-belted sidewalls to resist puncture
- Purpose-built, long lasting tread patterns



- Flexible "grippy" tread
- Aggressive side bite

WHEEL & TIRE SETS

40-SERIES	TRAIL		MUD		UTILITY		ROCK	
	DUAL-THREAT 29" 3,000 Miles 4,828 km	MUD XC 27" 3,000 Miles 4,828 km	MUD XC 29" 3,000 Miles 4,828 km	HARVESTER 27" 5,000 Miles 8,047 km	HARVESTER 28" 5,000 Miles 8,047 km	CRAWLER XR 28" 3,000 Miles 4,828 km	CRAWLER XG 30" 3,000 Miles 4,828 km	
4201 Accent ○	2883146 \$1,524 ⁹⁹	2884272 \$1,419 ⁹⁹	2884265 \$1,499 ⁹⁹	2882388 \$1,404 ⁹⁹	2883225 \$1,524 ⁹⁹	2882394 \$1,404 ⁹⁹	2882396 \$1,629 ⁹⁹	
4201 Matte Black ○	2883147 \$1,404 ⁹⁹	2884273 \$1,309 ⁹⁹	2884266 \$1,394 ⁹⁹	2882389 \$1,299 ⁹⁹	2883226 \$1,404 ⁹⁹	2882395 \$1,299 ⁹⁹	2882397 \$1,524 ⁹⁹	
4202 Accent ○	2883148 \$1,524 ⁹⁹	2884267 \$1,419 ⁹⁹	2884260 \$1,499 ⁹⁹	2882383 \$1,404 ⁹⁹	2883220 \$1,524 ⁹⁹	2881343 \$1,404 ⁹⁹	2881560 \$1,629 ⁹⁹	
4202 Matte Black ○	2883149 \$1,404 ⁹⁹	2884268 \$1,309 ⁹⁹	2884261 \$1,394 ⁹⁹	2882384 \$1,299 ⁹⁹	2883221 \$1,404 ⁹⁹	2881344 \$1,299 ⁹⁹	2881561 \$1,524 ⁹⁹	
4203 BEADLOCK Matte Black BEADLOCKS SOLD SEPARATELY ○						2881386 \$1,629 ⁹⁹		
4204 Accent ○	2883150 \$1,524 ⁹⁹	2884270 \$1,419 ⁹⁹	2884263 \$1,469 ⁹⁹	2882385 \$1,404 ⁹⁹	2883222 \$1,524 ⁹⁹	2881355 \$1,404 ⁹⁹	2881558 \$1,629 ⁹⁹	
4204 Matte Black ○	2883151 \$1,404 ⁹⁹	2884271 \$1,309 ⁹⁹	2884264 \$1,364 ⁹⁹	2882386 \$1,299 ⁹⁹	2883223 \$1,404 ⁹⁹	2881356 \$1,299 ⁹⁹	2881559 \$1,524 ⁹⁹	
4205 Luster ○						2881371 \$1,404 ⁹⁹	2881564 \$1,629 ⁹⁹	
4205 Matte Black ○	2883152 \$1,404 ⁹⁹	2884269 \$1,299 ⁹⁹	2884262 \$1,364 ⁹⁹	2882387 \$1,299 ⁹⁹	2883224 \$1,404 ⁹⁹	2881372 \$1,299 ⁹⁹	2881563 \$1,524 ⁹⁹	
4301 BEADLOCK Accent BEADLOCKS PRE-MOUNTED ○	2883219 \$1,849 ⁹⁹					2883213 \$1,734 ⁹⁹	2883211 \$1,954 ⁹⁹	
4301 BEADLOCK Matte Black BEADLOCKS PRE-MOUNTED ○	2883218 \$1,734 ⁹⁹					2883212 \$1,629 ⁹⁹	2883210 \$1,849 ⁹⁹	

50-SERIES	TRAIL		UTILITY		ROCK	
	ATTACK 2.0 28" 3,000 Miles 4,828 km	ATTACK 2.0 30" 3,000 Miles 4,828 km	CRAWLER AT 30" 3,000 Miles 4,828 km	HARVESTER 30" 5,000 Miles 8,047 km	CRAWLER XG 28" 3,000 Miles 4,828 km	CRAWLER XG 30" 3,000 Miles 4,828 km
5201 Accent ○	2883160 \$1,469 ⁹⁹	2883169 \$1,629 ⁹⁹	2889510 \$1,469 ⁹⁹		2883188 \$1,469 ⁹⁹	2883179 \$1,679 ⁹⁹
5201 Matte Black ○	2883159 \$1,354 ⁹⁹	2883168 \$1,524 ⁹⁹	2889511 \$1,364 ⁹⁹		2883187 \$1,354 ⁹⁹	2883178 \$1,574 ⁹⁹
5202 Accent ○	2883158 \$1,469 ⁹⁹	2883167 \$1,629 ⁹⁹	2889512 \$1,469 ⁹⁹	2885045 \$1,469 ⁹⁹	2883186 \$1,469 ⁹⁹	2883177 \$1,679 ⁹⁹
5202 Matte Black ○	2883157 \$1,354 ⁹⁹	2883166 \$1,524 ⁹⁹	2889513 \$1,364 ⁹⁹	2885046 \$1,364 ⁹⁹	2883185 \$1,354 ⁹⁹	2883176 \$1,574 ⁹⁹
5203 BEADLOCK Matte Black BEADLOCKS SOLD SEPARATELY ○	2883154 \$1,679 ⁹⁹	2883163 \$1,849 ⁹⁹	2889516 \$1,889 ⁹⁹	2885049 \$1,679 ⁹⁹	2883182 \$1,679 ⁹⁹	2883173 \$1,899 ⁹⁹
5301 BEADLOCK Accent BEADLOCKS PRE-MOUNTED ○	2883162 \$1,784 ⁹⁹	2883171 \$1,954 ⁹⁹	2889514 \$1,784 ⁹⁹	2885047 \$1,889 ⁹⁹	2883190 \$1,784 ⁹⁹	2883181 \$2,004 ⁹⁹
5301 BEADLOCK Matte Black BEADLOCKS PRE-MOUNTED ○	2883161 \$1,679 ⁹⁹	2883170 \$1,849 ⁹⁹	2889515 \$1,889 ⁹⁹	2885048 \$1,784 ⁹⁹	2883189 \$1,679 ⁹⁹	2883180 \$1,899 ⁹⁹

- LUG NUTS REQUIRED

REPLACEMENT CAPS

POLARIS

LUSTER	ALL WHEELS EXCEPT 5203 BEADLOCK & 5204	1521509-410 \$14 ⁹⁹
MATTE BLACK		1521509-521 \$14 ⁹⁹
LUSTER	5203 BEADLOCK	1522243-410 \$24 ⁹⁹
MATTE BLACK		1522243-458 \$24 ⁹⁹
HD MATTE BLACK	ALL WHEELS	5457498-458 \$22 ⁹⁹

PRO ARMOR

LUSTER	ALL WHEELS EXCEPT 5203 BEADLOCK & 5204	5453209-410 \$14 ⁹⁹
MATTE BLACK		5453209-458 \$14 ⁹⁹
MATTE BLACK	5204	1523063-458 \$14 ⁹⁹
LUSTER	5203 BEADLOCK	1523015-410 \$14 ⁹⁹
MATTE BLACK		1523015-458 \$14 ⁹⁹

12mm x 1.5 SPLINED LUG NUTS

○ LUG NUTS REQUIRED

16 SPLINED LUG NUTS WITH WRENCH ADAPTER	2879332 \$39 ⁹⁹
4 SPLINED LUG NUTS WITHOUT WRENCH	2879331 \$14 ⁹⁹
12mm x 1.5 SPLINED LUG WRENCH	2204966 \$9 ⁹⁹

2 WAYS TO PURCHASE

INDIVIDUAL WHEELS & TIRES
- OR -
COMPLETE SETS AS LISTED

VISIT Polaris.com/ProArmorGENERAL
TO BUILD YOUR CUSTOM SET & VERIFY FITMENT

Exclusively at Polaris Authorized Dealers or
Polaris.com/ProArmorGENERAL

WINCHES

TESTED **1,200+**
PULLS AT MAX LOAD

**OPERATES FULLY
SUBMERGED**

BUILT TO WITHSTAND
-20° F TEMPERATURES

**MILITARY
TESTED & APPROVED**



FEATURES & BENEFITS

PRO PRO HEAVY DUTY SERIES

BEST FOR PLOWING, HEAVY-DUTY OUTDOOR
CHORES & TRAIL RIDING

HD HEAVY DUTY SERIES

BEST FOR THE CASUAL
OFF-ROAD RIDER

**ALL POLARIS
ENGINEERED
WINCHES COME WITH:**



WARRANTY

- ✓ INTEGRATED WIRING, MOUNT, PREASSEMBLED
- ✓ HOOK WITH STRAP
- ✓ CUT STEEL GEARS & SEALED DRIVETRAIN
- ✓ SEALED PERMANENT MAGNET MOTOR



Retrieve cable 5x as fast as standard mode on other Polaris winches. Get back to riding or complete your task quicker.

- Set winch dial to N (Neutral) to manually pull the rope out and secure the hook to your anchor point
- Set winch dial to L (Low) for maximum pulling power while winching your load
- Set winch dial to H (High) for retrieving the rope 5x faster with Rapid Rope Recovery



NOT AVAILABLE

AUTO STOP TECHNOLOGY

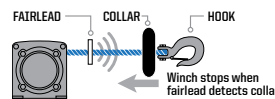

Auto Stop technology protects and extends the life of your winch by automatically stopping the winch at the end of pull to prevent over-spooling. While plowing, it prevents the plow frame from bending by stopping the winch once the plow has been lifted.



ADD AUTO STOP UPGRADE

2881288 • \$109⁹⁹
SYNTHETIC ROPE REQUIRED



PREMIUM SYNTHETIC ROPE

With its lightweight, yet extremely strong, design and superior flexibility, this 50 ft long synthetic rope is easy to handle and can stand up to any tough job.



ADD SYNTHETIC ROPE

2879187 • \$139⁹⁹



WIRELESS REMOTE

This convenient remote operates your Polaris winch wirelessly from within 50 ft of the vehicle. Operate your winch safely outside your vehicle while on the job site or trails.



ADD WIRELESS REMOTE

2881287 • \$139⁹⁹



MODEL

4,500 LB.

4,500 LB.

POLARIS GENERAL XP 1000/4 '20-23

2883861

POLARIS GENERAL 1000/4 '19-23

\$899⁹⁹

TOP SELLER
2883860

\$679⁹⁹

PLOWS & TRACKS

PLOW SYSTEMS

(WINCH REQUIRED,
SOLD SEPARATELY)

Choose a Glacier Plow System, designed to help you get the most out of your GENERAL during snowy months. Select a system based on your plowing needs with premium add-ons including a hydraulic lift system or additional plow accessories.

GLACIER PRO HD PLOW SYSTEM WITH HYDRAULICS

- System includes:
- Mount (2881763)
 - Frame (2880260)
 - 72" Steel Plow (2880270)
 - Hydraulic Angle (2889052)
 - Hydraulic Controller (2883391)
 - Plow Markers (2872726)
 - Plow Deflector (2858541)

» 3880014 • \$2,119⁹⁹
POLARIS GENERAL XP 1000/4 '20-23
POLARIS GENERAL 1000/4 '16-23

Requires lift method:
see winches below.

GLACIER PRO HD PLOW SYSTEM

- System includes:
- Mount (2881763)
 - Frame (2880260)
 - 66" Poly Plow (2880269)

» 3880015 • \$1,264⁹⁹
POLARIS GENERAL XP 1000/4 '20-23
POLARIS GENERAL 1000/4 '16-23

Requires lift method:
see winches and hydraulic lift options below.

GLACIER HD PLOW SYSTEM

- System includes:
- Mount (2883256)
 - Frame (2882927)
 - 72" Steel Plow (2889307)

» 3880016 • \$1,114⁹⁹
POLARIS GENERAL XP 1000/4 '20-23
POLARIS GENERAL 1000/4 '16-23

Requires lift method:
see winches and hydraulic lift options below.

GLACIER PRO HD PLOW SYSTEM

GLACIER PRO HD GIVES YOU

- » 72" or 66" Blades
- » Choice of poly or steel
- » Manual angle system standard



66" POLY BLADE
BEST FOR CORROSION RESISTANCE



72" STEEL BLADE
BEST FOR BIG JOBS YEAR AFTER YEAR

CREATE YOUR PLOW SYSTEM	STEP 1 SELECT A MOUNT	STEP 2 SELECT A FRAME	STEP 3 SELECT A LIFT METHOD	STEP 4 SELECT A BLADE	STEP 5 SELECT ACCESSORIES
MODELS	MOUNT	FRAME	WINCH	BLADES	ACCESSORIES
POLARIS GENERAL XP 1000/4 '20-23	2881763 \$354 ⁹⁹	TOP SELLER 2880260 \$484 ⁹⁹	Polaris PRO HD 4,500 lb. Winch 2883861 \$899 ⁹⁹ POLARIS GENERAL XP 1000/4 '20-23 POLARIS GENERAL 1000/4 '19-23	TOP SELLER 72" Steel 2880270 \$549 ⁹⁹ 66" Poly 2880269 \$459 ⁹⁹ TOP SELLER 66" Steel 2880268 \$409 ⁹⁹	72" Blade Snow Deflector 2858541 \$69 ⁹⁹ 72" HD Wear Bar 2879875 \$114 ⁹⁹ 72" Wear Bar 2204976 \$59 ⁹⁹ 66" Blade Snow Deflector 2879866 \$89 ⁹⁹ 66" HD Wear Bar 2879868 \$109 ⁹⁹ 66" Wear Bar 2879867 \$59 ⁹⁹ Plow Marker 2872726 \$39 ⁹⁹ 66" Blade Plow Shoe 2208864 \$29 ⁹⁹ Shear Pin 2205527 \$9 ⁹⁹ Replacement T Shear Pin 2204829 \$9 ⁹⁹ Extension for Tracks 2880267 \$269 ⁹⁹ Heavy Duty Deflector 2884160 \$154 ⁹⁹
POLARIS GENERAL 1000/4 '16-23			Hydraulic Plow Angle 2889052 \$569 ⁹⁹ POLARIS GENERAL 1000/4 '16-18 Hydraulic Plow Controller 2883391 \$214 ⁹⁹ POLARIS GENERAL XP 1000/4 '20-23 POLARIS GENERAL 1000/4 '16-23		

GLACIER HD PLOW SYSTEM

GLACIER HD GIVES YOU

- » 66" Blades
- » Choice of poly or steel
- » Manual angle system standard



66" POLY BLADE
BEST FOR CORROSION RESISTANCE



66" STEEL BLADE
BEST FOR BIG JOBS YEAR AFTER YEAR

Choose a steel blade for longevity and increased rigidity or a lightweight non-stick, poly blade that's easier on plowing surfaces.

CREATE YOUR PLOW SYSTEM	STEP 1 SELECT A MOUNT	STEP 2 SELECT A FRAME	STEP 3 SELECT A LIFT METHOD	STEP 4 SELECT A BLADE	STEP 5 SELECT ACCESSORIES
MODELS	MOUNT	FRAME	WINCHES	BLADES	ACCESSORIES
POLARIS GENERAL XP 1000/4 '20-23	2883256 \$249 ⁹⁹	2889307 \$549 ⁹⁹	Polaris HD 4,500 lb. Winch 2883860 \$679 ⁹⁹ POLARIS GENERAL XP 1000/4 '20-23 POLARIS GENERAL 1000/4 '19-23	66" Poly 2880269 \$459 ⁹⁹ TOP SELLER 66" Steel 2880268 \$409 ⁹⁹	66" Blade Snow Deflector 2879866 \$89 ⁹⁹ 66" HD Wear Bar 2879868 \$109 ⁹⁹ 66" Wear Bar 2879867 \$59 ⁹⁹ Plow Marker 2872726 \$39 ⁹⁹ 66" Plow Shoe 2208864 \$29 ⁹⁹ Shear Pin 2205527 \$9 ⁹⁹ Replacement T Shear Pin 2204829 \$9 ⁹⁹



PROSPECTOR PRO[®] TRACK MOUNTS

• Install in place of tires and wheels. Tracks sold separately.

» 2880649 • \$514⁹⁹

POLARIS GENERAL 1000/4 '16-23

» 2885117 • \$519⁹⁹

POLARIS GENERAL XP 1000/4 '20-23

PROSPECTOR PRO[®] 2.0 TRACK SYSTEM

» 2889487 • \$5,499⁹⁹

POLARIS GENERAL 1000/4 '16-23
POLARIS GENERAL XP 1000/4 '20-23

If using Glacier Pro Plow System, Track Plow Extension is required (2880267)

CHOOSE A PLOW SYSTEM

BUILD A PLOW SYSTEM

ACCESSORIES

WINDSHIELDS & REAR PANELS

DOORS

ROOFS & PROTECTION

STORAGE CAB COMFORT & HUNT

COOLERS

CONNECTED TECHNOLOGY & AUDIO

LIGHTING

WHEELS & TIRES

WINCHES, PLOWING & TRACKS

FOR THE LIFE OF YOUR RIDE

PARTS THAT PUSH THE LIMITS WITHOUT SACRIFICING STRENGTH AND DURABILITY.
We build our products so anyone with the right tools can maintain their vehicle.

POLARIS
ENGINEERED PARTS & LUBRICANTS

PARTS & GARAGE

MAINTENANCE

OIL & LUBRICANTS

MAINTENANCE FLUIDS

GARAGE ACCESSORIES & BATTERY CHARGERS

HD PARTS

SERVICE PARTS

TIRE SEALANT & TRAILERING

POLARIS POWER

39

MAINTENANCE TIP

BREAK-IN PERIOD

The break-in period for your new GENERAL is the first 25 hours of operation, or the time it takes to use the first two tanks of fuel. No single action on your part is as important as a proper break-in period. Careful treatment of a new engine will result in more efficient performance and longer life for the engine.

NOTICE: Excessive heat build-up during the first three hours of operation will damage close-fitted engine parts. Do not operate at full throttle or high speeds for extended periods during the first three hours of use.

SEE OUR LATEST MAINTENANCE TIPS AT GENERAL.POLARIS.COM/EN-US/SELF-HELP

AIR FILTER

A clogged air filter can restrict air flow to the engine leading to reduced engine performance, engine life or catastrophic failure.

BRAKE PADS

Maintaining and/or replacing brakes are critical to the safety and functionality of a vehicle. Brake pads should be checked for wear and oil or grease (petroleum products) contamination and brake discs should be checked for cracks, excessive corrosion or warping.

HALF SHAFT

Check for tears and punctures in the boot, which can lead to CV joint wear that can contribute to axle failure.

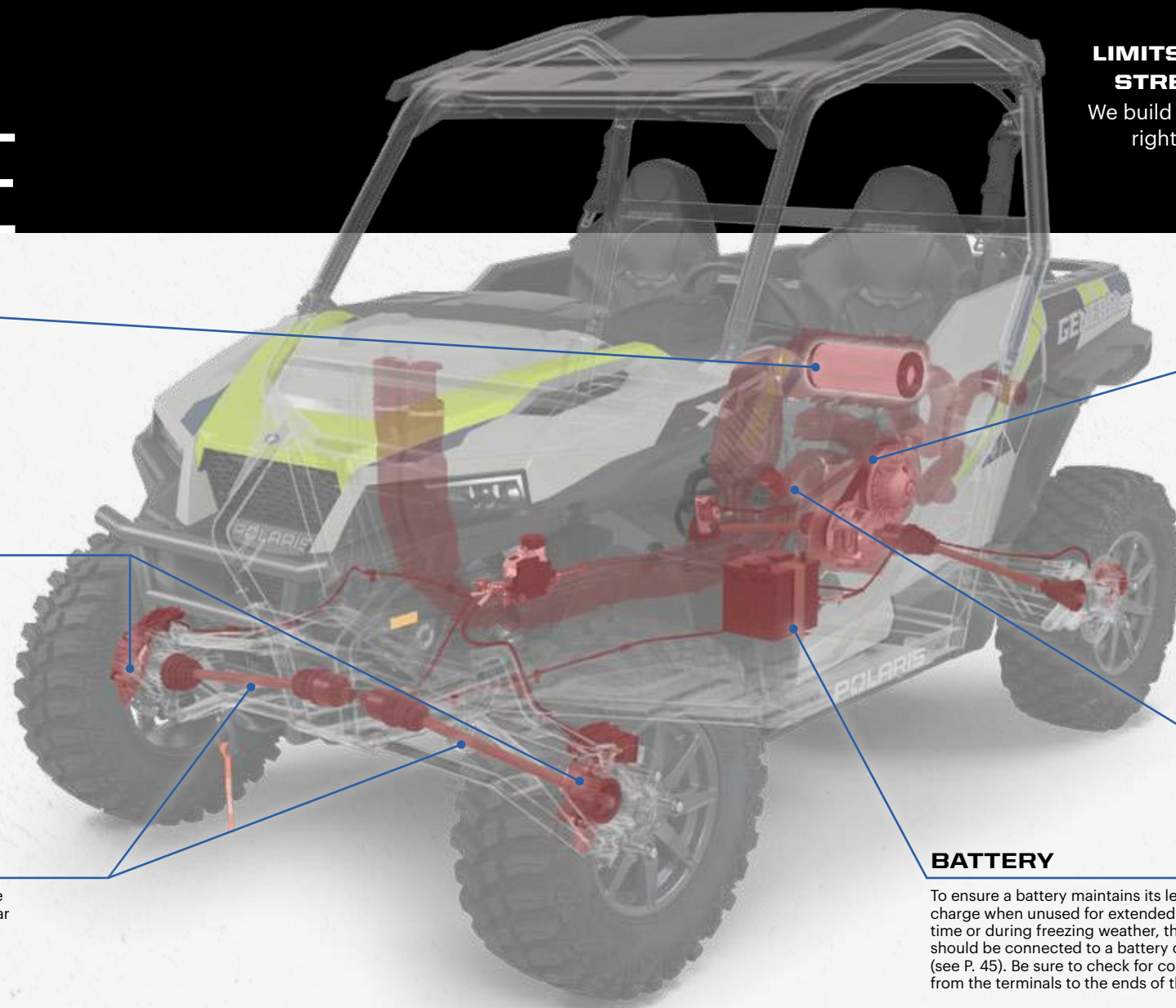

DRIVE BELT

Polaris Engineered belts deliver unmatched performance for your off-road vehicle. Developed and tested on all our engines for all environments and conditions. Check your belt for delamination, hour glassing and glazing.

BREAK-IN PERIOD

- Use lower gear (if available) while varying speeds and avoid wide open throttle for 5-10 miles / 8-16 km
- If no low gear is available, vary at moderate speeds while avoiding wide open throttle for 50 miles / 80 km

OUR INVESTMENT

- 40,000+ miles / 64,000+ km of field testing
- Thousands of dyno hours
- 18+ months of development (13,000+ design hours) per belt
- 1,500+ vehicle validation hours
- Collaboration with powertrain and clutch engineers

YOUR ADVANTAGE

- No clutch recalibration
- Less wear and tear due to heat
- Ensure maximum vehicle performance
- More time riding, less time wrenching
- Produced in collaboration with powertrain and clutch engineers to ensure a perfect fit, maximum performance and ultimate durability

OIL FILTER

Change oil filters with every oil change to provide the best engine protection and keep the engine operating at peak performance.

BATTERY

To ensure a battery maintains its level of charge when unused for extended periods of time or during freezing weather, the battery should be connected to a battery charger (see P. 45). Be sure to check for corrosion from the terminals to the ends of the cables.

FOLLOW RECOMMENDED SERVICE INTERVALS IN THE OWNER'S MANUAL

MAINTENANCE SCHEDULE

25 HRS / 250 Mi / 400 km

BREAK-IN MAINTENANCE

- ENGINE OIL & OIL FILTER:** CHANGE
- GENERAL LUBRICATION:** ALL FITTINGS, PIVOTS, CABLES, ETC.
- AIR FILTER:** INSPECT & REPLACE AS NEEDED
- EXHAUST SYSTEM:** INSPECT & CLEAN
INSPECT FOR LEAKAGE OR CARBON BUILD UP AT JOINTS
INSPECT & CLEAN SCREEN TYPE SPARK ARRESTOR

50 HRS / 500 Mi / 800 km

6 MONTHS

- EXHAUST SYSTEM:** INSPECT & CLEAN
INSPECT FOR LEAKAGE OR CARBON BUILD UP AT JOINTS
INSPECT & CLEAN SCREEN TYPE SPARK ARRESTOR
- GENERAL LUBRICATION:** ALL FITTINGS, PIVOTS, CABLES, ETC.
- DRIVE BELT:** INSPECT & ADJUST
REPLACE AS NEEDED

100 HRS / 1,000 Mi / 1,600 km

12 MONTHS

- ENGINE OIL & OIL FILTER:** CHANGE
- DRIVE BELT:** INSPECT & ADJUST
REPLACE AS NEEDED
- TRANSMISSION FLUID:** CHANGE
- AIR FILTER:** INSPECT & REPLACE AS NEEDED
- EXHAUST SYSTEM:** INSPECT & CLEAN
INSPECT FOR LEAKAGE OR CARBON BUILD UP AT JOINTS
INSPECT & CLEAN SCREEN TYPE SPARK ARRESTOR

150 HRS / 1,500 Mi / 2,400 km

18 MONTHS

- ENGINE OIL & OIL FILTER:** CHANGE
- BATTERY:** TEST, CLEAN & CHECK FLUID LEVEL
REPLACE AS NEEDED
- DRIVE BELT:** INSPECT & ADJUST
REPLACE AS NEEDED
- TIRES:** INSPECT CONDITION & PRESSURE
- EXHAUST SYSTEM:** INSPECT & CLEAN
INSPECT FOR LEAKAGE OR CARBON BUILD UP AT JOINTS
INSPECT & CLEAN SCREEN TYPE SPARK ARRESTOR

200 HRS / 2,000 Mi / 3,200 km

24 MONTHS

- ENGINE OIL & OIL FILTER:** CHANGE
- BRAKE PADS & FLUID:** INSPECT & CLEAN
REPLACE BRAKE FLUID
REPLACE AS NEEDED
- SPARK PLUGS:** INSPECT
REPLACE AS NEEDED
- AIR FILTER:** INSPECT & REPLACE AS NEEDED
- EXHAUST SYSTEM:** INSPECT & CLEAN
INSPECT FOR LEAKAGE OR CARBON BUILD UP AT JOINTS
INSPECT & CLEAN SCREEN TYPE SPARK ARRESTOR

250 HRS / 2,500 Mi / 4,023 km

30 MONTHS

- ENGINE OIL & OIL FILTER:** CHANGE
- BATTERY:** TEST, CLEAN & CHECK FLUID LEVEL
REPLACE AS NEEDED
- DRIVE BELT:** INSPECT & ADJUST
REPLACE AS NEEDED
- GENERAL LUBRICATION:** ALL FITTINGS, PIVOTS, CABLES, ETC.
- EXHAUST SYSTEM:** INSPECT & CLEAN
INSPECT FOR LEAKAGE OR CARBON BUILD UP AT JOINTS
INSPECT & CLEAN SCREEN TYPE SPARK ARRESTOR

300 HRS / 3,000 Mi / 4,828 km

36 MONTHS

- ENGINE OIL & OIL FILTER:** CHANGE
- AIR FILTER:** INSPECT & REPLACE AS NEEDED
- GEARCASE & TRANSMISSION:** REPLACE FLUIDS
- EXHAUST SYSTEM:** INSPECT & CLEAN
INSPECT FOR LEAKAGE OR CARBON BUILD UP AT JOINTS
INSPECT & CLEAN SCREEN TYPE SPARK ARRESTOR

CHECK YOUR OWNER'S MANUAL FOR ADDITIONAL RECOMMENDED SERVICE ITEMS AND VEHICLE-SPECIFIC TIMING

OIL



PS-4 FORMULATIONS BEST PROTECTION, BEST PERFORMANCE

Our new PS-4 5W-50 formulation and PS-4 Extreme Synthetic 0W-50 have been designed to provide the best fluid technologies for long lasting wear protection. These formulations include a new Polaris exclusive additive system to keep the engine cleaner from deposit build-up to maximize power and powersports-grade synthetic base stocks that provide the ultimate in engine protection.

PS-4 5W-50 FULL-SYNTHETIC OIL

Optimal for ambient operating temperatures of -40° F to 100° F

» 1 Quart 2876244 » 1 Gallon 2876245 » 16 Gallons 2876247 » 55 Gallon Drum 2876246 » 330 Gallon Tote 2878814

PS-4 0W-50 EXTREME FULL-SYNTHETIC OIL

Optimal for ambient operating temperatures of -45° F to 130° F

» 1 Quart 2889395 » 1 Gallon 2889396 » 16 Gallons 2889397 » 55 Gallon Drum 2889398 » 330 Gallon Tote 2889399

OIL CHANGE KITS

PS-4 5W-50		PS-4 EXTREME 0W-50
These convenient kits include everything needed including filter and oil volume per vehicle		
PART NUMBER	VEHICLE FITMENT	PART NUMBER
2202166	RANGER/RZR/SPORTSMAN 570, TWIN 600, TWIN 700, TWIN 800	2890056
2879323	RANGER, POLARIS GENERAL 900-1000, RZR 900-1000, RS1	2890057
2877473	RANGER/SPORTSMAN 300-500, SPORTSMAN/SCRAMBLER 500/850/1000	2890055
2881696	RZR TURBO	2890058

ENGINE WEAR TEST LOWER NUMBER = LESS WEAR OF CRITICAL ENGINE PARTS LESS WEAR MEANS LONGER ENGINE LIFE

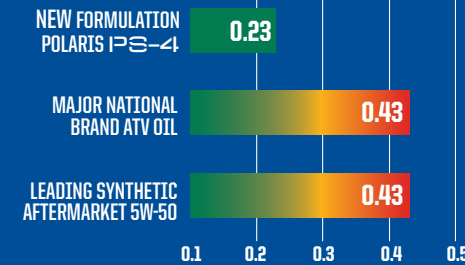

ASTM D4172. In 3rd party against 11 competitive products Polaris had 40% or better wear protection compared to all of the test products.

THE BEST PROTECTION

• At least 40% improved wear protection compared to previous Polaris PS-4 formulation and all aftermarket oils tested

Best engine protection against wear for the longest engine life.

DEPOSIT TEST LOWER DEPOSITS = MAXIMUM POWER

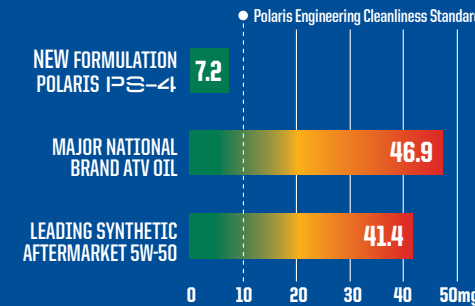

ASTM D6395. In 3rd party against 9 competitive products Polaris PS-4 had less than half the deposits compared to the next closest product. No other tested products met Polaris Engineering standards for deposit cleanliness.

MAXIMUM PERFORMANCE

• New improved PS-4 formulation provides 33% less deposits than previous PS-4 formula

• At least 50% less deposits than all aftermarket oils tested

The cleanest engine for maximum power and performance!

POLARIS EXTREME SYNTHETICS

Our new PS-4 Extreme Synthetic 0W-50 formulation applies only to the **absolute highest performance** products we sell, for ultimate protection and performance in the most extreme conditions.



• Our best extreme high temp formulation, excellent for severe high temperatures and for racing, even at temps over 130°F.

• Provides easier starting and cold temperature protection, even to extreme cold temps of below -45°F.

• Latest in premium synthetic PAO and Ester base stocks along with careful balance of moly and ZDDP additives for ultimate long lasting wear protection.

• Polaris exclusive clean engine additive system reduces deposits and carbon build-up for peak performance and power.



POLARIS INVESTS IN EACH OIL AT AND ABOVE THESE LEVELS

12+ DEDICATED
TEAM MEMBERS

FOCUSED ON
POLARIS OIL

18+
MONTHS

DEVELOPMENT
& TESTING

76,000+
HOURS

DYNO
TESTING

2.2/3.5 MILLION+
MILES/KM

FIELD
TESTING

MAINTENANCE FLUIDS



ENGINE OIL

Maximum protection for your 4-cycle engine.

Change every 100 hours, 6 months or 500 miles / 800 km.



AGL

Protect gears, drive chain and bearings from scoring and wear.

Change every 100 hours, 12 months or 1,000 miles / 1,600 km.

- » 1 QT • 2878068
- » 1 GALLON • 2878069
- » 2.5 GALLONS • 2878070
- » 55 GALLONS • 2879594

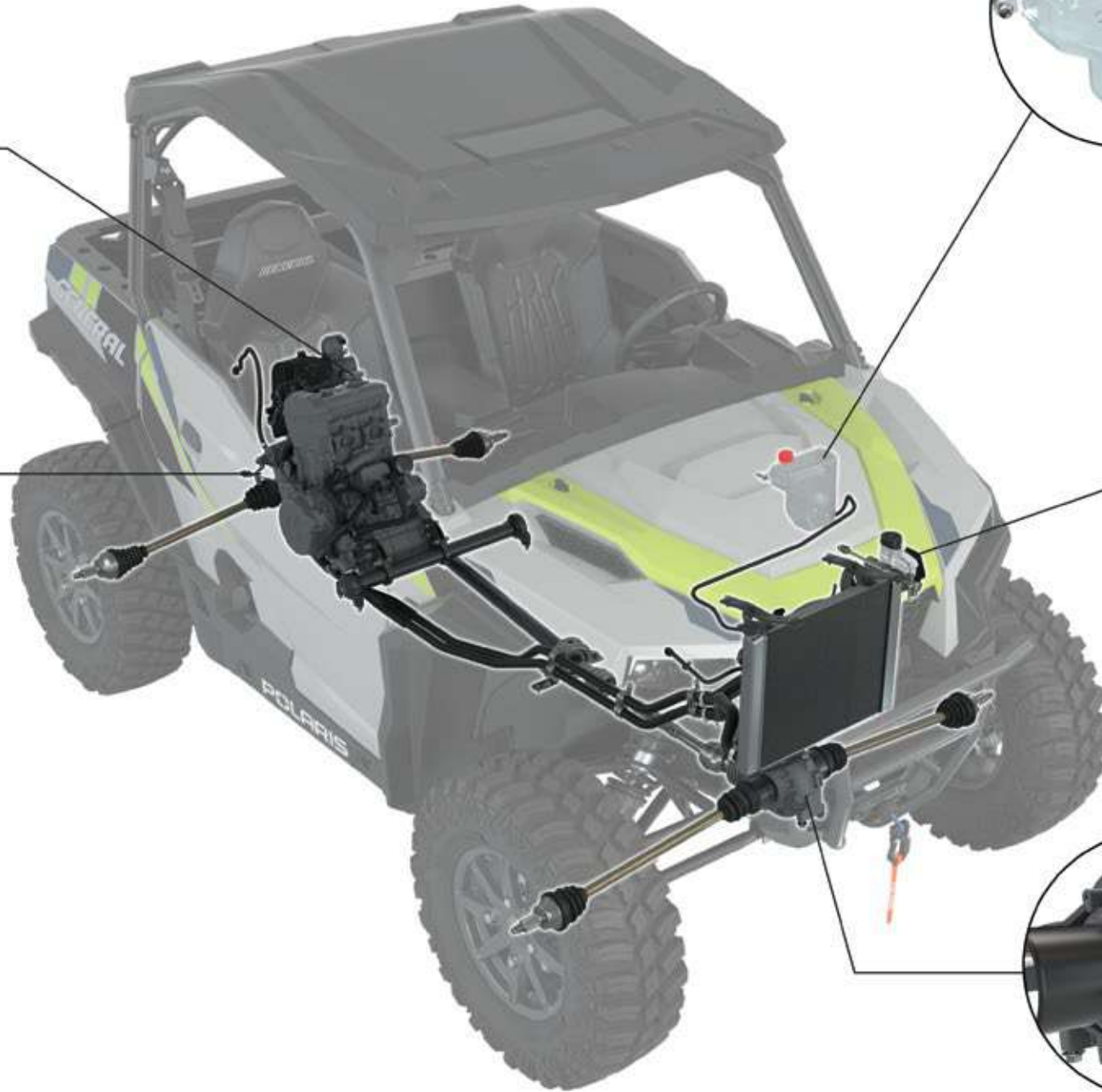

ANTI-FREEZE

Prevent corrosion on metal components, eliminate scaling and maximize cooling system performance.

Change every 60 months.

- » 1 QT • 2880514
- » 1 GALLON • 2880513
- » 55 GALLONS • 2880512



DOT 4 BRAKE FLUID

A high-quality brake fluid designed for use in Polaris hydraulic brakes.

Change every 200 hours, 2 years or 2,000 miles / 3,200 km.

- » 12 OZ • 2872189



ORV MAINTENANCE KIT

Everything you need, in the correct fluid volumes, to maintain your drive train and keep your vehicle in top operating condition

- Includes: 2 Spark Plugs, 1 Air Filter, 2 quarts PS-4, 1 Oil Filter, 2 pints Transmission Fluid, 1 quart AGL, 1 Crush Washer, 1 Paper Funnel

» 2830544

GENERAL 1000/4 '16-23



PREMIUM GAS SHOCK OIL

- » 1 QT • 2874124
WALKER EVANS RACING® REBUILDABLE SHOCKS
- » 1 QT PREMIUM • 2870995
- » 2.5 GALLONS PREMIUM • 2872279
FOX® REBUILDABLE SHOCKS



SUSPENSION/ U-JOINT GREASE

- » 3 OZ • 2871515
- » 14 OZ • 2871551



CHAIN LUBRICANT

- Provides superior anti-wear and shock protection
- » 16 OZ AEROSOL 2872348



ALL-SEASON GREASE TUBE

- Specialized water-resistant lubricant
- » 3 OZ • 2871322
- » 14 OZ • 2871423



ANGLE DRIVE FLUID

- Extreme pressure, anti-wear and high viscosity film lubrication for maximum protection
- » 1 QT • 2889280



GENERATOR OIL

- 4-cycle engine oil
- » 1 QT • 2879383



CARBON CLEAN

- Ultimate fuel and injection system cleaner
- » 12 OZ • 2881413



ADVANCED FUEL TREATMENT

- Dual antioxidant formula protects jets and fuel system from gum and varnish
- » 12 OZ • 2881416

GARAGE ACCESSORIES



PREMIUM MAINTENANCE TOOL KIT

- Includes everything you need to work on and repair Polaris vehicles
 - Lifetime warranty on select tools
- » 2830565 • **\$499⁹⁹**



FLUID FUNNEL

- Easily add oil with high accuracy
- » 2830552 • **\$12⁹⁹**



FUNNELS

- Unique capped design eliminates spills and contaminants
- » BLUE • 2830574 • **\$8⁹⁹**
 » RED • 2830575 • **\$8⁹⁹**
 » GREEN • 2830576 • **\$8⁹⁹**



HANDHELD PUMP SPRAYER

- Half gallon portable sprayer, lightweight and easy to use
- » 2830570 • **\$12⁹⁹**

BATTERY CHARGERS



NOCO® BATTERY CHARGER - 1 AMP

- Ensure your battery is charged with the NOCO® Battery Charger 1 Amp
 - Includes Boost Eyelet Cable with X-Connector Adapter (2830546)
- » 2830567 • **\$64⁹⁹**



NOCO® BATTERY CHARGER - 2 AMP

- Ensure your battery is charged with the NOCO® Battery Charger 2 Amp
 - Includes Boost Eyelet Cable with X-Connector Adapter (2830546)
- » 2830568 • **\$99⁹⁹**



1,000 AMP ULTRASAFE LITHIUM JUMP PACK

- Delivers 1,000 amps for jump starting a dead battery in seconds
- » 2830547 • **\$124⁹⁹**



JUMP PACK PROTECTION CASE

- Lightweight, durable and rugged custom exterior
- » 2830548 • **\$18⁹⁹**



GREASE GUN

- Comfort grip handle and heavy-duty follower spring for high pressure applications and easy priming
- » 14 OZ • 2830569 • **\$34⁹⁹**
 FOR 14 OZ ALL-SEASON & U-JOINT



GREASE GUN

- Enables easy application of grease
- » 3 OZ • 2871312 • **\$39⁹⁹**
 FOR 3 OZ ALL-SEASON & U-JOINT



FLEX SPOUT

- Fits all Polaris quart, gallon and 2.5 gallon bottles
- » 2871285 • **\$3⁹⁹**



PUMP

- Fits 1 and 2.5 gallon bottles
- » 2870465 • **\$7⁹⁹**



FLUID SYRINGE

- Easily add and remove fluid from your vehicle
- » 2830553 • **\$29⁹⁹**



2D BATTERY-OPERATED SIPHON PUMP

- Liquid transfer pumps 5-6 quarts/min suctioning power
- » 2830513 • **\$16⁹⁹**



POLARIS HEAVY-DUTY SCRUBBER WIPES

- » 90 CT • 2830441 • **\$19⁹⁹**



POLARIS SHOP TOWELS

- » 200 CT WITH DISPENSER 2830402 • **\$22⁹⁹**
- » 200 CT REFILL • 2830403 • **\$15⁹⁹**
- » 64 CT REFILL • 2830440 • **\$4⁹⁹**



FLEXIBLE CLUTCH COVER TOOL

- The perfect tool for hard to reach CVT cover bolts
- » 2830572 • **\$14⁹⁹**



OIL FILTER WRENCH

- Remove Polaris ORV oil filters with ease
- » 2830550 • **\$7⁹⁹**



FLUID TRAY

- Holds up to 8 quarts of fluid
- » 2830551 • **\$19⁹⁹**



POLARIS MAGNETIC PARTS TRAY

- » SILVER • 2830432 • **\$12⁹⁹**



POLARIS 33" TELESCOPIC MAGNET

- » BLACK • 2830435 • **\$4⁹⁹**



POLARIS 12" HI-TORQUE RATCHETING DRIVER

- » BLACK / BLUE • 2830434 • **\$19⁹⁹**



POLARIS LED POCKET FLASHLIGHT

- » BLACK • 2830436 • **\$24⁹⁹**

PARTS & GARAGE

MAINTENANCE

OIL & LUBRICANTS

MAINTENANCE FLUIDS

GARAGE ACCESSORIES & BATTERY CHARGERS

HO PARTS

SERVICE PARTS

TIRE SEALANT & TRAILERING

POLARIS POWER

HD HEAVY DUTY PARTS

All Polaris parts are developed and tested to help you get the most out of your ride. We're taking the passion of our riders, workers and outdoor enthusiasts to the next level with HD Parts.

Engineered and designed for:

- Greater durability
- Enhanced performance
- Greater wear and tear capabilities
- All weather conditions



DRIVE BELTS

The enhanced rubber material compound in these belts keep them cool in extreme heat, while our patented cord treatment process maximizes the transfer of horsepower to the ground for those customers hauling heavy loads.

OE	HD HEAVY DUTY PARTS
3211149	
3211169	3212326
3211196	
3211113	3212328



OIL FILTERS

The advanced synthetic material built into these filters offers the highest debris holding capacity, maintains oil flow and maximizes performance.

OE	HD HEAVY DUTY PARTS
2540086	2522498



WHEELS & TIRES

Class leading durability for off-road performance and traction for confident driving in extreme conditions.

- » 1524022-458 • HD WHEEL - 14x7*
- » 5417507 • PRO ARMOR HD-K - 29x10R14*
- » 5457498-458 • HD WHEEL CENTER CAP*
- » 5415756 • PRO ARMOR XD-K FRONT
- » 5415757 • PRO ARMOR XD-K REAR

* SHOWN

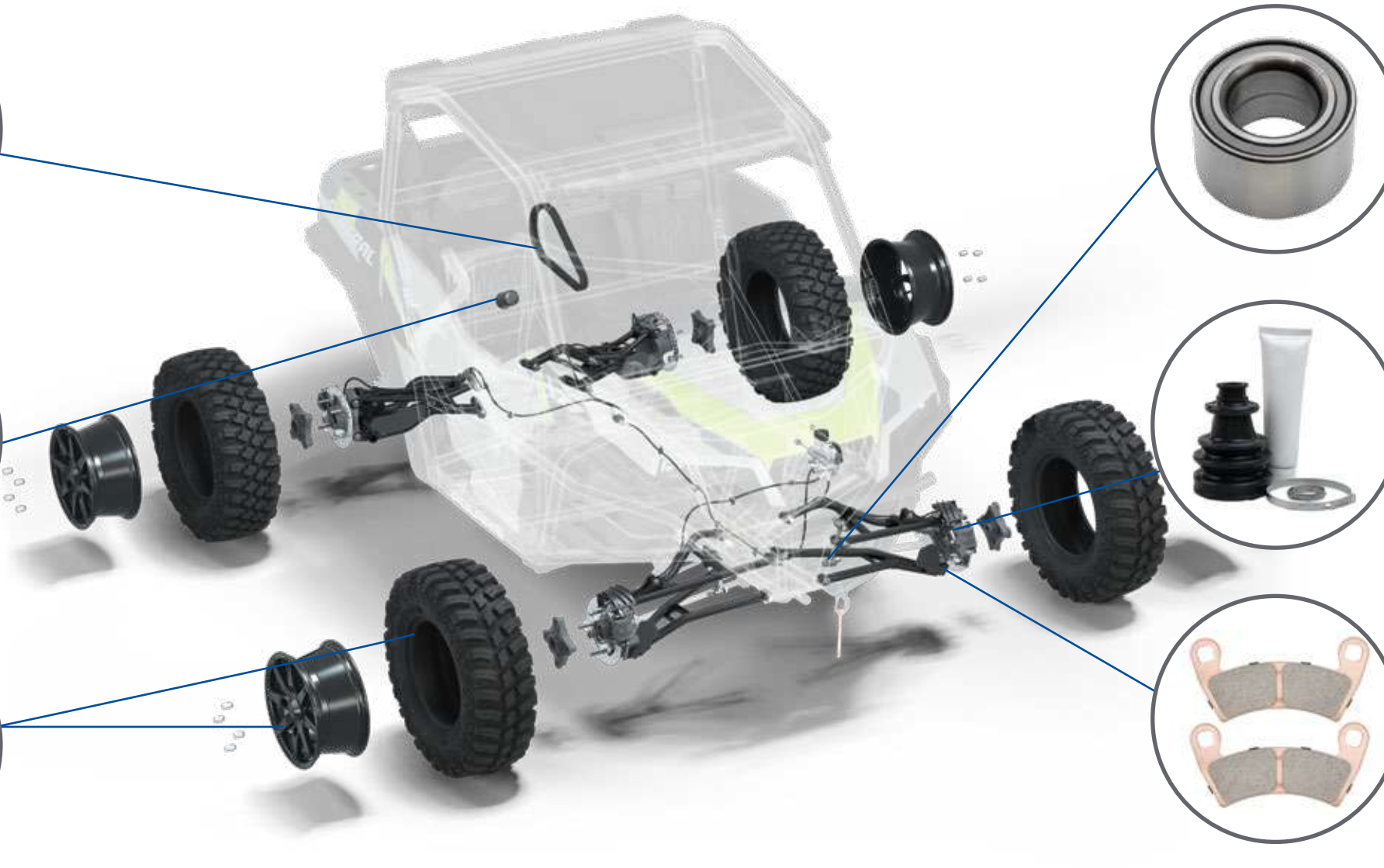

WHEEL BEARINGS

Fully sealed for added protection against intrusions. Made of a higher grade steel for extended life in extreme conditions.

LOCATION	OE	HD HEAVY DUTY PARTS
FRONT	3514924	3515090
REAR		



NEW CV BOOT KIT

TPE rubber compound for maximum puncture and tear resistance, includes (1) boot, grease and clamp to replace OE stock part. Provides increased durability for riding in extreme conditions.

OE	HD HEAVY DUTY PARTS
3236165	2209923



BRAKE PADS

Engineered to provide longer life and better stopping power while riding in extreme conditions.

OE	HD HEAVY DUTY PARTS
2205949	2208933
2203318	2208936

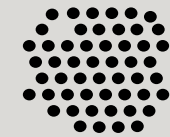
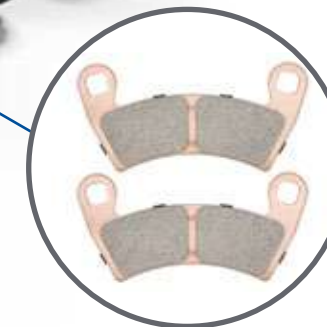

SAND



MUD



WATER



EXTREME COLD



EXTREME HEAT UP TO 130° F



HEAVY PAYLOADS



EXTENDED LIFE

PARTS & GARAGE

MAINTENANCE

OIL & LUBRICANTS

MAINTENANCE FLUIDS

GARAGE ACCESSORIES & BATTERY CHARGERS

HD PARTS

SERVICE PARTS

TIRE SEALANT & TRAILERING

POLARIS POWER

Claims made based off testing and performance of Polaris HD Parts against standard OEM parts made by Polaris and competitor brands under normal use.

For more information regarding Polaris HD parts including vehicle compatibility, installation and maintenance, please contact your authorized Polaris ORV dealer.

VISIT POLARIS.COM/SHOPGENERAL TO LEARN MORE

SERVICE PARTS

Polaris Engineered service parts deliver unmatched performance and fit for your off-road vehicle.

All service parts are engineered specifically for your machine. Which means everything is designed, tested and perfected to maximize the life of your ride. Getting Polaris Engineered parts is a decision that pays off in the long run, because it ensures there is a long run.



**SHOP FOR SERVICE PARTS ONLINE
OR VISIT YOUR POLARIS DEALER.**

OVER
100,000
PARTS
AVAILABLE!



CHECK OUT OUR PARTS FINDER ON POLARIS.COM

FOR EASY PARTS LOOK-UP, PARTS IDENTIFICATION, VIEWS OF ASSEMBLIES & MORE!

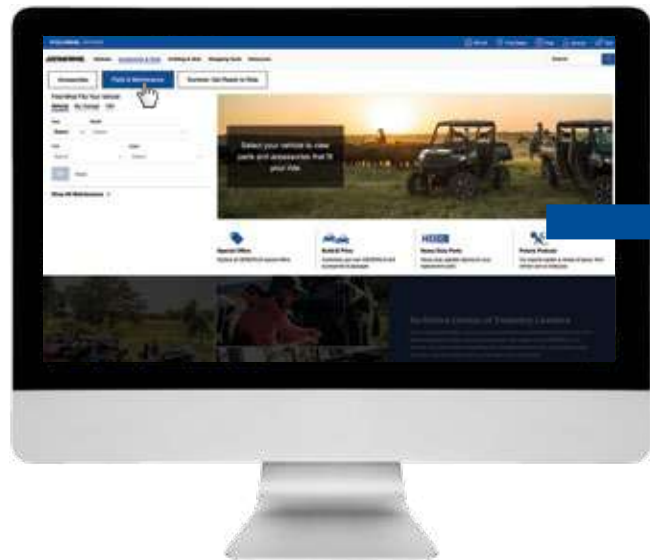

STEP 1

Visit **Polaris.com/GENERAL**
Click the **"Accessories & Parts"** tab
Click **"Parts & Maintenance"**

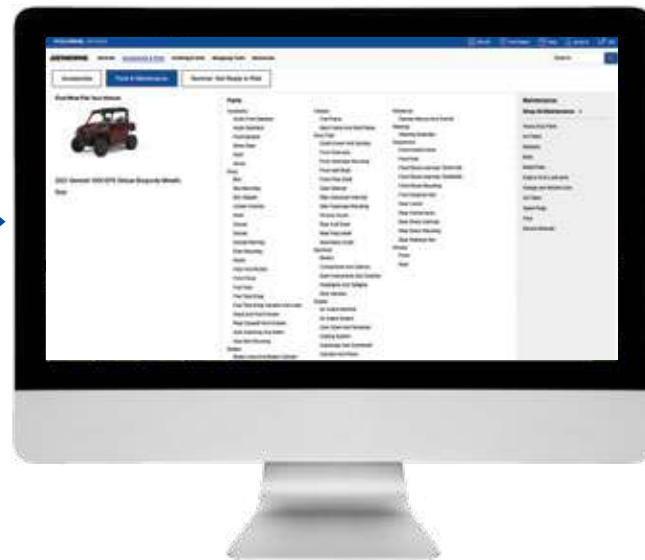

STEP 2

Enter **vehicle year/model** or shop by
part number



STEP 3

Clearly see what parts are
required and **order**

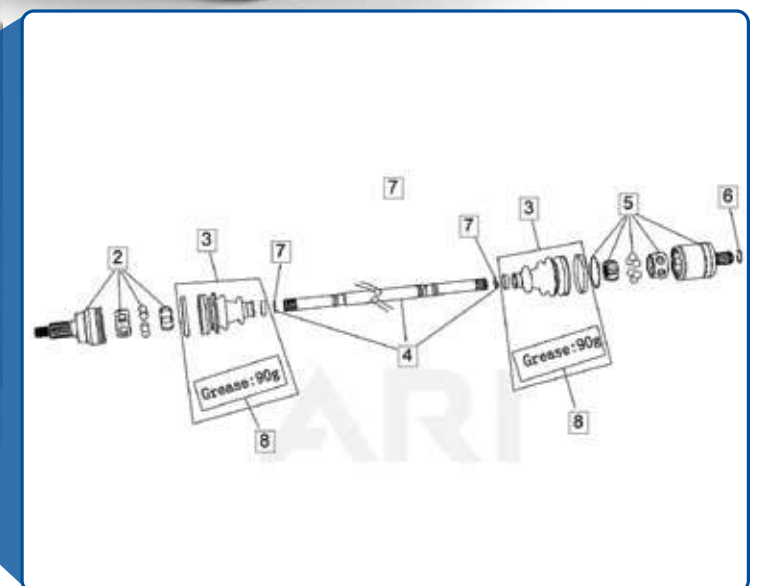

CV BOOT REPAIR KIT*

- A quick trail-side fix to increase trail time
- The flexible and durable boot material expands over a cone tool for CV boot repairs, without disassembling CV axles
- Universal fit – works as a temporary fix for most powersports axles
- All components fit inside the cone, and a cover is provided for compact durable storage
- Easily fits in a cargo box, attached to the roll cage, in the glovebox or many other storage locations



Items shown are contained inside cone

FIX ON THE GO | TEMPORARY COVERAGE

UTV CV BOOT REPAIR KIT

Kit includes the following items:

- (1) Expandable XL CV Boot
- (1) Reusable Cone Tool
- (2) CV Boot Clamps
- (1) Tube of Silicone Lube
- (1) Grease Packet
- (1) Cone Cover

» 2830526 • \$29⁹⁹

UTV TRAIL BOOT ONLY

» 2830527 • \$14⁹⁹

ATV

- » CV REPAIR KIT 2830528 • \$25⁹⁹
- » TRAIL BOOT ONLY 2830529 • \$14⁹⁹

SEE HOW THE CV BOOT REPAIR KIT WORKS AT POLARIS.COM/MAINTENANCE-VIDEOS

HOW TO INSTALL

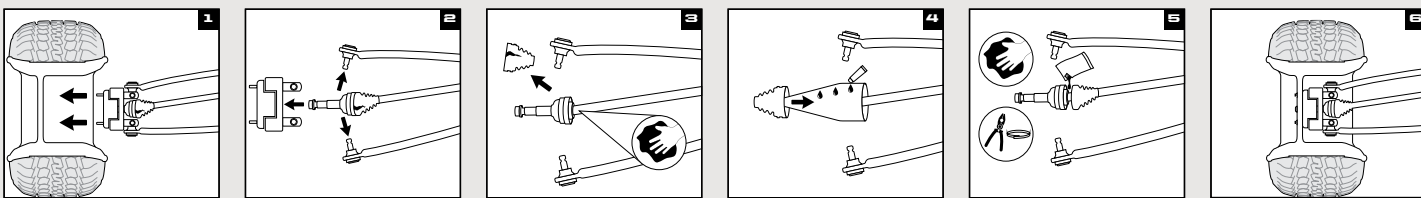

- Remove wheel and axle nut.
- Remove brake caliper, hub, tie rod and upper and lower ball joints.
- Remove old boot and clean joint.
- Spread silicone lube on entire cone tool. Slide boot over cone tool, large end first. See package for outer boot instructions.
- Empty the bag of grease into the CV joint/boot, clean sealing points and install clamps.
- Reassemble tie rod, ball joints, brake caliper, axle nut, tire and wheel.

Refer to your service manual for further instructions and torque specifications.
*Designed for temporary CV boot repair. Purchase the OEM CV Boot for a permanent repair.

TIRE SEALANT

HOW IT WORKS

Tire sealant remains liquefied inside the tire until a leak develops in the tire or wheel.



Once a leak occurs, the tire sealant rushes out of the tire and quickly creates a permanent solid plug.

The plug maintains the pressure of the tire so you can continue your ride.

PREMIUM TIRE SEALANT

- Instantly seals and repairs rim, bead leaks and punctures up to .25" on standard tires and .75" on heavy ply tires
- Helps maintain air pressure for the life of the tire
- Helps seal the tire bead against the wheel
- 100% water soluble for easy cleanup
- Will not rust, corrode or pit wheels
- Creates permanent repair
- Remains fluid and effective in temperatures down to -45° F
- Easily installed through existing tire valve stem with valve core removed

- » 32 OZ • 2830484 • \$20⁹⁹
- » 1 GALLON • 2830485 • \$72⁹⁹
- » 5 GALLONS • 2830486 • \$298⁹⁹
- » 5 GALLONS PUMP • 2830487 • \$133⁹⁹
- » 55 GALLONS • 2830489
- » 275 GALLONS • 2830488



HOW MUCH TIRE SEALANT DO YOU NEED?

$$\frac{\text{TIRE HEIGHT (IN.)} \times \text{TIRE WIDTH (IN.)}}{5} = \text{OUNCES REQUIRED PER TIRE}$$

$$\frac{27'' \times 10''}{5} = 54 \text{ oz}$$

FOR A FULL APPLICATION CHART, VISIT POLARIS.COM/TIRESEALANTCHART

BRING IT EVERYWHERE

TRAILERING



CALIBER® RAMP PRO

- Designed for ATVs and UTVs up to 50" wide
 - Integrated grip glides for ultimate traction
 - Folding sides for easy transportation and storing
- » 52" x 90" • 2884576 • \$694⁹⁹



ALUMINUM ARCHED LOADING RAMPS

- Capacity for up to 3,000 lbs, 1,500 lbs per ramp
- » 76" x 12" • 2,000 lb • 2875384 • \$359⁹⁹
- » 88" x 12" • 3,000 lb • 2875386 • \$649⁹⁹



LIGHTWEIGHT TRI-FOLD RAMPS

- Ramp folds up for transport
- Capacity for up to 1,500 lbs
- Safety straps included
- » 72" x 51" • 2875385 • \$349⁹⁹
- » 82" x 51" • 2875860 • \$399⁹⁹



FOLDING ALUMINUM ARCHED RAMPS

- Ramp folds up for transport
- Up to 1,500 lb total capacity, 750 lb per individual ramp
- Safety straps included
- » 88" x 12" • 2875387 • \$454⁹⁹

HITCHES

3:1 HITCHES VERSATILE 3 IN 1 FUNCTIONALITY

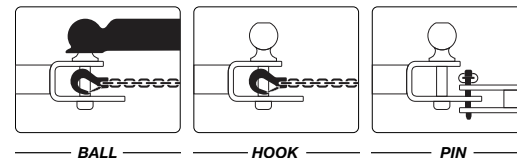

- Ball, hook and pin design
- Durable, rust resistant steel with black powdercoated finish
- Removable ball
- HD 5/8" pin and clip



HITCH WITH 2" BALL

- » 2" x 2" RECEIVER 2830522 • \$39⁹⁹
- » 1 1/4" x 1 1/4" RECEIVER 2830523 • \$39⁹⁹



1 7/8" BALL

- 1 7/8" replacement ball for hitch
- Designed to work with 3:1 Hitch
- » 2830524 • \$9⁹⁹



RECEIVER HITCH

- » 2" RECEIVER TONGUE 2875320 • \$44⁹⁹



TRAILER BALL 3/4" SHANK

- » 1 7/8" BALL • 2877602 • \$14⁹⁹
- » 2" BALL • 2877603 • \$14⁹⁹

STRAPS & ROPES



RECOVERY STRAP

- 2" x 30'
- 18,000 lb maximum load / 9,000 lb maximum vehicle weight
- Comes with carry bag
- » 2884033 • \$59⁹⁹



RATCHET STRAP

- 1.5" x 15' straps, 2 Pack
- Heavy duty webbing
- 5,500 lb maximum load, 1,833 lb working load
- » 2884031 • \$44⁹⁹



RATCHET STRAP

- 2" x 20' Ratchet Straps
- Heavy duty webbing, floating D-rings, double J-hooks
- 10,000 lb maximum load, 3,300 lb working load
- » 2884032 • \$34⁹⁹



SHOCK STRAPS

- 1.5" 3,000 lb breaking strength
- Keeps tension on tie-down straps to secure load, 2 Pack
- » 1.5" x 15' • 2883296 • \$84⁹⁹
- » 1.5" x 7' • 2883295 • \$74⁹⁹

COVERS



TRAILERABLE COVER BY POLARIS

- » 2-SEAT • 2881841 • \$369⁹⁹
- POLARIS GENERAL XP 1000 '20-23
- POLARIS GENERAL 1000 '16-23
- » 4-SEAT • 2881787 • \$444⁹⁹
- POLARIS GENERAL XP 4 1000 '20-23
- POLARIS GENERAL 4 1000 '17-23



POLARIS SxS CAMO FIELD COVER

- » 2882160 • \$129⁹⁹
- POLARIS GENERAL XP 1000/4 '20-23
- POLARIS GENERAL 1000/4 '16-23

POLARIS POWER

FOR THE WORKERS, PLAYERS AND SAVE-THE-DAYERS.

BACKED BY A



WARRANTY

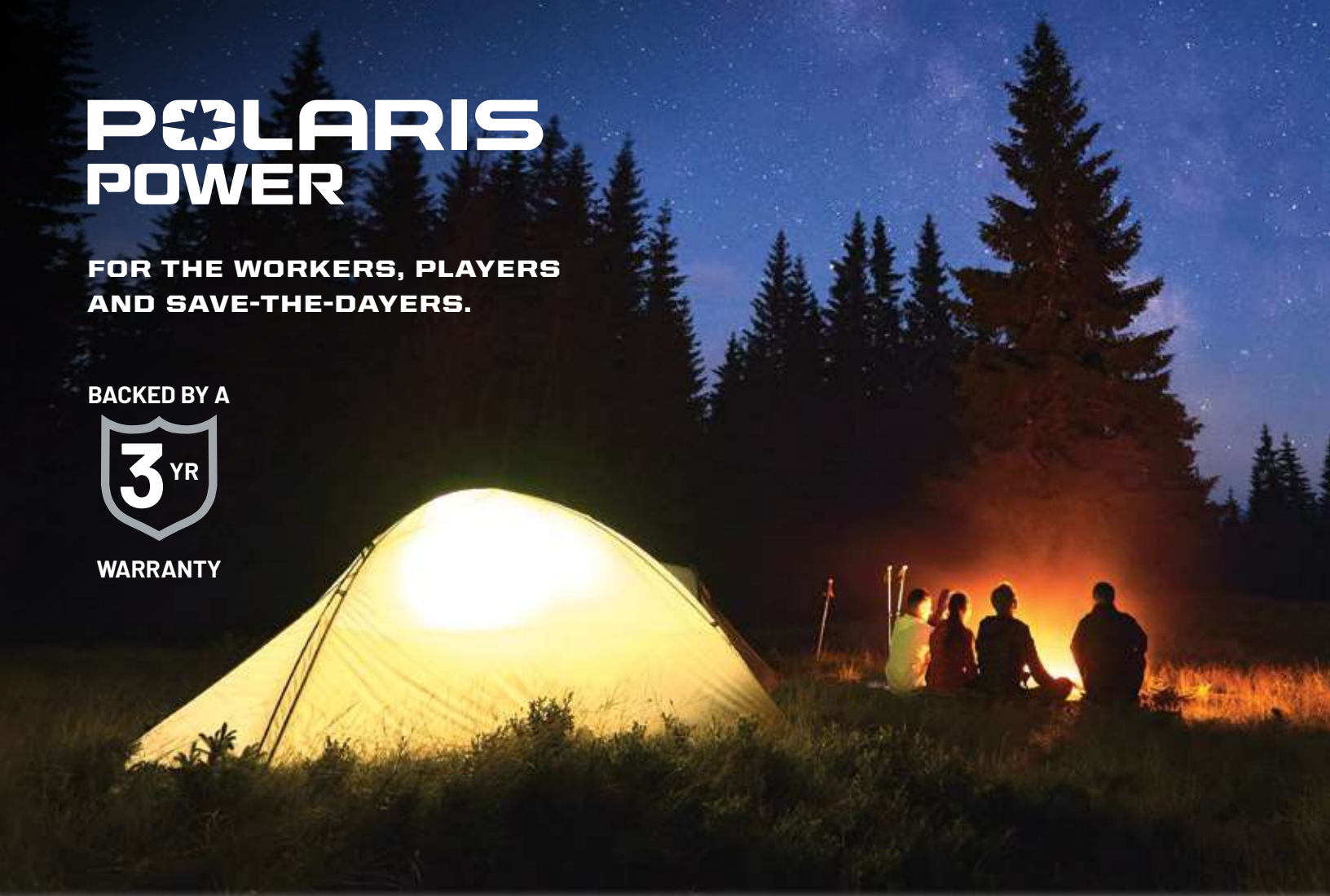

VISIT POLARISPOWER.COM FOR ALL PRODUCT FEATURES



THE POWER TO EMPOWER

At Polaris Power, we are committed to powering more. We proudly donate 3% of our profits by providing portable power to areas affected by natural disasters and the organizations providing relief in North America.



P2000i

Inverter Generator

2830532

\$799 99

1600

Running Watts

2000

Starting Watts

16.7

Max Amps at 120V

7.6

Run Time at 25% Load w/ Smart Throttle (hrs)

62

Noise Level at 25% Load (dBA)

FEATURES



Extension Cord Management



Multi Functional Digital Display



Illuminated Control Panel



Multi Handle Design



Parallel Capable

BEST USED FOR



Tailgating



Off-Grid



Camping



ACCESSORIES

2830536
2830541

INVERTER PARALLEL KIT
ALL WEATHER COVER

2884866
2879383

HIGH ALTITUDE MODIFICATION KIT
GENERATOR OIL

Read, understand and follow your owner's manual. Never operate a generator indoors. Generator exhaust contains carbon monoxide vapors and exposure can result in severe injury or death. Gasoline is highly flammable and explosive under certain conditions. Always use extreme care whenever handling gasoline.

PARTS & GARAGE

MAINTENANCE

OIL & LUBRICANTS

MAINTENANCE FLUIDS

GARAGE ACCESSORIES & BATTERY CHARGERS

HO PARTS

SERVICE PARTS

TIRE SEALANT & TRAILERING

POLARIS POWER



NEW P2500iEBT* Inverter Generator	2830537	\$1,149 99	2000 Running Watts	2500 Starting Watts	17 Max Amps at 120V	8 Run Time at 25% Load w/ Smart Throttle (hrs)	65 Noise Level at 25% Load (dBA)
---	---------	-------------------	------------------------------	-------------------------------	-------------------------------	--	--

FEATURES

- Polaris Mobile App Compatible
- Digital Fuel Gauge
- Carbon Monoxide Detection & Auto Shut Off
- Electric Start with Electric Choke
- Parallel Capable

BEST USED FOR

- Camping
- Tailgating
- Off-Grid



ACCESSORIES	2830536 2830540	INVERTER PARALLEL KIT ALL WEATHER COVER	2889540 2879383	HIGH ALTITUDE MODIFICATION KIT GENERATOR OIL
--------------------	--------------------	--	--------------------	---

P3200iE Inverter Generator	2830533	\$1,599 99	2800 Running Watts	3200 Starting Watts	23.3 Max Amps at 120V	10.1 Run Time at 25% Load w/ Smart Throttle (hrs)	67 Noise Level at 25% Load (dBA)
--------------------------------------	---------	-------------------	------------------------------	-------------------------------	---------------------------------	---	--

FEATURES

- Key Fob Remote Start
- Multi Functional Digital Display
- Fuel Gauge
- Extension Cord Management
- Parallel Capable

BEST USED FOR

- Camping
- One Room Backup
- DIY Remodeling



ACCESSORIES	2830536 2830541	INVERTER PARALLEL KIT ALL WEATHER COVER	2884866 2879383	HIGH ALTITUDE MODIFICATION KIT GENERATOR OIL
--------------------	--------------------	--	--------------------	---

*Check with your local dealer for availability.

Read, understand and follow your owner's manual. Never operate a generator indoors. Generator exhaust contains carbon monoxide vapors and exposure can result in severe injury or death. Gasoline is highly flammable and explosive under certain conditions. Always use extreme care whenever handling gasoline.



P5500 / P6500

2830534 / 2830535
Open Frame Generator **\$1,499⁹⁹ / \$1,699⁹⁹**

5000 / 6000 Running Watts (P5500 / P6500)	5500 / 6500 Starting Watts (P5500 / P6500)	20/30 Max Amps at 120/240V	5 Run Time (hrs)	75 Noise Level (dBA)
--	---	---	-------------------------------	-----------------------------------

FEATURES



Extension Cord Management



Fuel Gauge



Electric Start



Rough Terrain Wheel

BEST USED FOR



Construction



Home Backup



RV'ing



ACCESSORIES
2830542 2884867 ALL WEATHER COVER
HIGH ALTITUDE MODIFICATION KIT

2879383 GENERATOR OIL

Read, understand and follow your owner's manual. Never operate a generator indoors. Generator exhaust contains carbon monoxide vapors and exposure can result in severe injury or death. Gasoline is highly flammable and explosive under certain conditions. Always use extreme care whenever handling gasoline.



INTRODUCING THE POLARIS POWER PRESSURE WASHER 3700

NEW PRESSURE WASHER 3700

- 3700 PSI at 2.5 GPM
- Simpson Pro-Axial Cam Pump
- CRX 4-stroke 225cc OHV engine
- Low-oil shut-down system
- 10" pneumatic tires
- Heavy-duty steel engine plate
- 1.25" tubular construction
- Professional spray gun
- 50' Morflex® hose

» 2830573 • **\$849⁹⁹**

PRESSURE WASHER ACCESSORIES



NEW EXTENSION HOSE

- Designed to be highly flexible and kink resistant
- This cold water hose is equipped with standard M22 threaded connections, a dual o-ring and polyurethane outer jacket that is non-marring and abrasion-resistant for improved durability

» 2830577 • **\$79⁹⁹**



NEW TURBO NOZZLE

- 3700 PSI .25" QC turbo nozzle delivers a strong jet of oscillating water that cleans faster than standard nozzles
- Made for reliability and durability, this nozzle is easy to use and great at cleaning hard to remove dirt and debris

» 2830579 • **\$54⁹⁹**

JERSEYS & GLOVES



OFF-ROAD RIDING JERSEYS

\$34⁹⁹ / \$29⁹⁹ (adult/youth)

Mesh ventilated panels for maximum airflow
Elastic sleeves with non-restrictive cuffs



- BLACK**
JERSEY | S-3XL | 2862718
GLOVES | S-3XL | 2862726
YOUTH JERSEY | S-XL | 2862723
- ORANGE**
JERSEY | S-3XL | 2862719
GLOVES | S-3XL | 2862729
- TEAL**
JERSEY | S-3XL | 2862720
GLOVES | S-3XL | 2862727
YOUTH JERSEY | S-XL | 2862724
- GREEN**
JERSEY | S-3XL | 2862721
GLOVES | S-3XL | 2862730
- BLUE**
JERSEY | S-3XL | 2862722
GLOVES | S-3XL | 2862728
YOUTH JERSEY | S-XL | 2862725

OFF-ROAD RIDING GLOVES

\$24⁹⁹

Adjustable wrist closure for a custom fit
Silicon finger grips and neoprene knuckle protection



TEKVEST[®]
FREESTYLE

\$349⁹⁹

Black | S-3XL | 2862577



HEATED APPAREL

Keep warm even on the coldest days with Polaris Heated Apparel. By keeping the heat close to your body, you can stay out for a longer, more comfortable ride. The Polaris Heated Apparel lineup includes the Heated Vest, Heated Base Layers and a Heated Glove Liner for both men and women. Easily control your heat setting with the touch of a button.



WOMEN'S | \$199⁹⁹
Black | S-3XL | 2833036

MEN'S | \$199⁹⁹
Black | S-3XL | 2833022



\$139⁹⁹
Black | S-3XL | 2833044

NEW HEATED VESTS

WARMTH WITH THE TOUCH OF A BUTTON

- Perfect for any outdoor activity
- Down-proof machine washable material with 160g of insulation for warmth with or without the heater turned on
- Powered by a small rechargeable battery (included) that can also be used to charge a cellphone; battery not machine washable, remove prior to washing
- Easily adjust between four heat settings for changing weather conditions with built-in buttons

NEW HEATED GLOVE LINER

KEEP YOUR HANDS WARM ON FROSTY DAYS

- Designed to fit under all Polaris riding gloves for an extra layer of warmth to keep you out riding longer
- Easily adjust your heat level by pressing a button on the bottom part of the glove



WOMEN'S | \$129⁹⁹
Top | S-3XL | 2833033
Bottom | S-3XL | 2833034

MEN'S | \$129⁹⁹
Top | S-3XL | 2833031
Bottom | S-3XL | 2833032

NEW HEATED BASE LAYERS

ADJUSTABLE HEAT CLOSE TO YOUR BODY, MAXIMUM COMFORT IN CHANGING CONDITIONS

- Intended for use as a base layer
- Features lightweight, moisture-wicking fabric to give you the most comfortable layering to wear on all of your cold weather adventures, on or off the trail
- Includes multiple heat panels for evenly distributed heat for maximum warmth and comfort
- Powered by a small rechargeable battery (included) that can be used to charge a cellphone; battery not machine washable, remove prior to washing
- Easily adjust between four heat settings for changing weather conditions with built-in buttons

FOR
POLARIS

NEW
RED
XS-4XL
2833054



ALTITUDE

509 ALTITUDE 2.0 HELMET

LIGHTWEIGHT DESIGN, PERFORMANCE-INFUSED STYLE AND GOPRO® MOUNTING CAPABILITY

SHELL \$329⁹⁵
• Thermoplastic poly alloy outer shell

WEIGHT
• Composite as low as 1,200g
• Carbon fiber as low as 1,150g

FEATURES
• Strong, lightweight construction of carbon fiber or composite
• Superior fit for all-day comfort
• Pro Series breath box for complete protection, removable for optimal air flow
• One-piece eyeport creates draft-free seal with 509 goggles
• Magnetic Fidlock™ chin-strap technology and integrated GOPRO™ mount
• DOT- and ECE 22.05-approved

FIDLOCK™



NEW
RADIANT GREEN
XS-4XL
2833051



BLACK
XS-4XL
2861469



\$429⁹⁵
CARBON FIBER
BLACK/LIME
XS-4XL
2861473

FOR
POLARIS

NEW
PINK
XS-4XL
2833050



TACTICAL

TACTICAL 2.0 HELMET

COMBINES STYLE WITH VERSATILITY FOR ULTIMATE COMFORT AND CONTROL

SHELL \$229⁹⁵
• Shock-resistant, injection-molded thermoplastic

FEATURES
• Innovative Venturi Vent pulls moist air from helmet without cold wind coming in
• Eyeport seal is co-integrated with the removable breath box and creates a draft-free seal with 509 goggles and a clear field of view
• Magnetic Fidlock™ chin-strap technology
• DOT- and ECE 22.06-approved

FIDLOCK™



MATTE BLACK
XS-4XL
2862468



GRAY
XS-4XL
2862469



RED/BLACK
XS-4XL
2862467



ORANGE
XS-4XL
2862471



NEW
BLUE
XS-2XL
2833143

TENACITY

TENACITY 4.0 HELMET

COMBINATION OF MODERN STYLE AND PREMIUM PROTECTION WITH INCREDIBLE VALUE

SHELL \$139⁹⁹
• Shock-resistant, injection-molded thermoplastic

WEIGHT
• 1,500g

FEATURES
• Through-flow, full-helmet ventilation
• ProClip quick release chin strap allows you to fasten the chin strap in seconds
• Removable breath box and removable, washable liner
• Tool-less adjustable roost shield
• DOT- and ECE 22.05-approved



NEW
RADIANT GREEN
XS-2XL
2833142



BLACK
XS-2XL
2861557



BLACK/GRAY
XS-2XL
2861558



BLACK/LIME
XS-2XL
2861559



WHITE/RED
XS-2XL
2861561



PINK
XS-2XL
2861562

GOGGLES



ORANGE
2862561



LIME
2862559

509 KINGPIN OFF-ROAD GOGGLE

PREMIUM MATERIALS, ATTRACTIVE PRICE \$49⁹⁵

FEATURES
• Oversized spherical lens delivers optimal peripheral vision
• Metal tear-off posts provide strength and durability
• Quick-change technology allows you to run the best lens tint for conditions



BLUE
2862562



STEALTH
2862560



BLACK
2862557



RED/BLACK
2862558

509 MX6 OFF-ROAD GOGGLE

SUPER WIDE FIELD OF VIEW, ENGINEERED FOR DIRT \$99⁹⁵

FEATURES
• PC outer lens with anti-scratch coating, and internal anti-fog coating
• Outriggers with latch system for quick lens change
• 45mm strap with silicone to hold strap in place



NEW
RED/GRAY
S-3XL | 2833029



BLACK
S-3XL | 2861432



NEW
ORANGE
S-3XL | 2833027



NEW
BLUE
S-3XL | 2833028



BLACK
S-3XL | 2861434

FORCE PUFFER JACKET

PACKABLE JACKET OFFERS LIGHTWEIGHT PROTECTION, IDEAL FOR ANY ACTIVITY

- 140g 3M® Thinsulate®
- Plenty of storage with two external hand pockets and one internal media pocket
- Rugged YKK® zippers
- Great for travel, compacts into pocket

\$139⁹⁹

SOFTSHELL JACKET

VERSATILE LIGHTWEIGHT JACKET THAT'S PERFECT FOR EVERYDAY WEAR

- Casual jacket armed with rugged and warm features for everyday wear
- Superior DWR prevents precipitation from saturating the jacket's exterior
- Lined with soft fleece for warmth
- Removable hood and underarm venting, three external pockets and one internal chest pocket

\$129⁹⁹



BLACK
S-3XL | 2862569



NAVY
S-3XL | 2862570

WORK VEST

RUGGED AND DURABLE VEST THAT'S IDEAL AS AN OUTDOOR LAYER

- Made of durable nylon fabric to make it the ideal vest for work
- 80g 3M® Thinsulate® Insulation provides great warmth
- Vest comes with plenty of pockets to store your valuables

\$99⁹⁹



GRAY
S-3XL | 2860863



BLACK
S-3XL | 2861608

WORK JACKET

WARM AND RUGGED JACKET THAT'S TOUGH FOR WORK AND STYLISH FOR PLAY

- Coated with Durable Water Repellency (DWR) to provide water-resistance
- Built in action back for increased range of motion
- 80g 3M® Thinsulate® for added warmth with brushed flannel trim
- One inner and four outer pockets for storage

\$159⁹⁹

REVOLVE VEST

REVERSIBLE

DURABLE AND WARM REVERSIBLE VEST OFFERS TWO STYLES IN ONE

- Durable windbreak outer fabric helps protect from the elements
- 140g 3M® Thinsulate® insulation keeps you warm in cold weather
- Reversible vest offers two unique styles in one

\$99⁹⁹



NEW
RED
S-3XL | 2833030



BLACK/GRAY
S-3XL | 2862565

WINDBREAKER JACKET

LIGHTWEIGHT, WINDPROOF JACKET THAT PROVIDES PROTECTION WHILE RIDING

- 100% polyester windproof fabric
- Lightweight construction makes it easy to pack
- Three external pockets allow for maximum storage

\$99⁹⁹



BLACK
S-3XL | 2861541

FLANNEL JACKET

SHERPA FLEECE LINED JACKET DELIVERS EXCEPTIONAL WARMTH AND COMFORT

- Warm sherpa lined fleece material
- Insulation to keep you warm
- Plenty of storage for your valuables

\$99⁹⁹



CHARCOAL
S-3XL | 2860865



BRONZE
S-3XL | 2860864





STAMP HOODIE

\$54⁹⁹

NEW Green | S-3XL | 2833061
Black | S-3XL | 2862484
Navy | S-3XL | 2861500



CREW SWEATSHIRT

\$49⁹⁹

NEW Gray | S-3XL | 2833067
Black | S-3XL | 2862488
Navy | S-3XL | 2861497



ICON HOODIE

\$54⁹⁹

NEW Black/Red | S-3XL | 2833065
Gray | S-3XL | 2862487
Green | S-3XL | 2861495



TITAN MID-LAYER

\$89⁹⁹

NEW Red | S-3XL | 2833026
Black | S-3XL | 2862568
Blue/Orange | S-3XL | 2862567



NORTHSTAR MID-LAYER

\$89⁹⁹

NEW Black/Lime | S-3XL | 2833024
Tan | S-3XL | 2862450



JOURNEY HOODIE

\$69⁹⁹

NEW Navy | S-3XL | 2833066
Black | S-3XL | 2862489



ICON LONG SLEEVE

\$29⁹⁹

NEW Lime | S-3XL | 2833083
Gray/Red | S-3XL | 2862505
Black | S-3XL | 2861584



DASH LONG SLEEVE

\$29⁹⁹

NEW Black/Red | S-3XL | 2833082
Navy | S-3XL | 2861583
Black | S-3XL | 2861582



PERFORMANCE LONG SLEEVE

\$39⁹⁹

NEW Gray | S-3XL | 2833168
Black | S-3XL | 2862507



NEW STAPLE HOODIE

\$54⁹⁹

Black | S-3XL | 2833068
Navy | S-3XL | 2833069
Green | S-3XL | 2833070



TECH FULL-ZIP HOODIE

\$64⁹⁹

NEW Red | S-3XL | 2833064
Gray | S-3XL | 2861493



ROGUE HOODIE

\$54⁹⁹

NEW Black | S-3XL | 2833062
NEW Navy | S-3XL | 2833063
Gray | S-3XL | 2862485



ICON TEE

\$24⁹⁹

NEW Lime | S-3XL | 2833079
Green | S-3XL | 2862501
Black | S-3XL | 2861570



NEW GRAPHIC TEE

\$24⁹⁹

Dark Gray | S-3XL | 2833086
Forest Green | S-3XL | 2833087



FLAG TEE

\$24⁹⁹

Navy | S-3XL | 2862500
White | S-3XL | 2862582

BALL CAPS



NEW
LEATHER PATCH HAT
\$24.99
Black | One Size | 2833129
Gray | One Size | 2833130



NEW
STAPLE CAP
\$24.99
Black | One Size | 2833127
Navy | One Size | 2833128



HIGHLAND CAP
\$24.99
NEW Navy | One Size | 2833126
Tan | One Size | 2860893
Gray | One Size | 2862544



ELLIPSE PATCH TRUCKER HAT
\$24.99
Orange | One Size | 2833124
Light Gray | One Size | 2862539
Gray | One Size | 2861531
Black | One Size | 2861533
Navy | One Size | 2861532



CORE CAP
\$24.99
NEW Red | One Size | 2833123
Gray | One Size | 2862594
Navy | One Size | 2861523
Black | One Size | 2861524



TONAL HAT
\$24.99
Black/Red | One Size | 2861526
Navy | One Size | 2861525



NEW
JOURNEY CAP
\$24.99
Black | One Size | 2833136
Blue | One Size | 2833137



CHECKERED HAT
\$24.99
Blue | One Size | 2861520
Black | One Size | 2861522
Gray | One Size | 2861521



RETRO CAP
\$24.99
NEW Black | One Size | 2833125
Navy | One Size | 2862538
Gray/Red | One Size | 2869542
Gray/Orange | One Size | 2861536

CAMO APPAREL



CAMO SOFTSHELL JACKET
\$129.99
Camo | S-3XL | 2861543



MEN'S CAMO REVOLVE VEST
\$99.99
Camo | S-3XL | 2862572



MEN'S CAMO PURSUIT HOODIE
\$49.99
Camo | S-3XL | 2862494



WOMEN'S CAMO PURSUIT HOODIE
\$49.99
Camo | S-3XL | 2862517



NEW
PURSUIT HOODIE
\$54.99
Black | S-3XL | 2833076
Green | S-3XL | 2833077



CAMO NECK GAITER
\$12.99
Camo | One Size | 2861948



STEALTH CAMO HAT
\$24.99
Camo | One Size | 2861527



HUNTER ORANGE HAT
\$24.99
Orange | S/M | 2860892
Orange | L/XL | 2862545



HUNTER ORANGE BEANIE
\$19.99
Orange | One Size | 2862595



NEW
RADIANT GREEN
 S-3XL | 2833039

BLACK
 S-3XL | 2862457



NEW
BLACK
 S-3XL | 2833041

NEW
RADIANT GREEN
 S-3XL | 2833040

BLUE
 S-3XL | 2862460

REVOLVE VEST

DURABLE AND WARM REVERSIBLE VEST OFFERS TWO STYLES IN ONE

- Durable windbreak outer fabric protects you from the elements
- 140g 3M® Thinsulate® insulation keeps you warm in cold weather
- Reversible for two unique styles in one

\$99⁹⁹

SOFTSHELL JACKET

VERSATILE LIGHTWEIGHT JACKET THAT'S PERFECT FOR EVERYDAY WEAR

- Casual jacket armed with rugged and warm features
- Superior DWR prevents precipitation from saturating the jacket's exterior
- Lined with 280g of soft fleece for warmth
- Removable hood and underarm venting
- Three external pockets and one internal chest pocket

\$129⁹⁹



BLACK
 S-3XL | 2861433

FORCE PUFFER JACKET

PACKABLE JACKET OFFERS LIGHTWEIGHT PROTECTION AND INCREDIBLE WARMTH

- 140g 3M® Thinsulate®
- Two external hand pockets, one internal media pocket
- Rugged YKK® zippers
- Compactable into travel pocket

\$139⁹⁹



BLACK
 S-3XL | 2862563

BLUE
 S-3XL | 2862564

WORK JACKET

WARM AND RUGGED JACKET THAT'S TOUGH FOR WORK AND STYLISH FOR PLAY

- 100% nylon shell is coated with DWR to help keep you dry
- 80g 3M® Thinsulate® for added warmth with brushed flannel trim
- Built-in action back for increased range of motion
- One inner and four outer pockets for storage

\$159⁹⁹



NEW
RADIANT GREEN
 S-3XL | 2833042

BLACK/GRAY
 S-3XL | 2862458

TITAN MID-LAYER

EXTREMELY WARM YET BREATHABLE MID-LAYER, PERFECT FOR RIDING

- 319g Polartec® Thermal Pro® Rib Sweater provides great warmth
- Breathable material moves sweat to the outer surface
- Nylon overlay is comfortable and light

\$89⁹⁹



NEW
STAPLE HOODIE

\$54⁹⁹

Black | S-3XL | 2833095
 Gray | S-3XL | 2833096



JOURNEY HOODIE

\$69⁹⁹

NEW Radiant Green | S-3XL | 2833098
 Black | S-3XL | 2862515
 Blue | S-3XL | 2862516



TECH FULL-ZIP HOODIE

\$64⁹⁹

NEW Black | S-3XL | 2833097
 Maroon | S-3XL | 2861509
 Gray | S-3XL | 2861508



ICON HOODIE

\$54⁹⁹

NEW Gray | S-3XL | 2833099
 White | S-3XL | 2862512



ADVENTURE CREW

\$49⁹⁹

NEW Black/Radiant Green | S-3XL | 2833100
NEW Green | S-3XL | 2833101
 Dusty Rose | S-3XL | 2862513
 Black | S-3XL | 2862514



NEW
ADVENTURE LONG SLEEVE

\$29⁹⁹

Gray | S-3XL | 2833107
 Navy | S-3XL | 2833108



NEW
CORE TANK

\$19⁹⁹

Black | S-3XL | 2833161
 Gray | S-3XL | 2833160



NEW
FLAG TEE

\$24⁹⁹

Gray | S-3XL | 2833163
 White | S-3XL | 2833162



ADVENTURE TEE

\$24⁹⁹

NEW Pink | S-3XL | 2833104
 Black Frost | S-3XL | 2862628
 Teal | S-3XL | 2862629

APPAREL

JERSEYS & GLOVES & HEATED APPAREL

HELMETS & GOGGLES

MEN'S APPAREL

BALL CAPS

CAMO APPAREL

WOMEN'S APPAREL

HOME & COLLECTIBLES



RETRO CLOCK
12" | 2868662 | \$29.99



NEW
POLARIS LED SIGN
31.5" x 6.5" | 2862736 | \$259.99



ALUMINUM SIGN
22" | 2860867 | \$129.99



WOOD SIGN
24" x 10.5" | 2860866 | \$74.99



RETRO GLASSES (SET OF 2)
2866265 | \$14.99



12oz CAMPER MUG
2861612 | \$29.99



23oz WATER BOTTLE
2862685 | \$24.99



WOODEN COASTERS
2860869 | \$24.99



HITCH COVER
2861623 | \$34.99



LICENSE PLATE HOLDER
2862687 | \$19.99



POLARIS PARKING SIGN
2869934 | \$19.99



POLARIS FLAG
3' x 5' | 2869928 | \$24.99



15oz CAMPFIRE MUG
2861613 | \$19.99



PREMIUM KOOZIE
2860829 | \$7.99



LEATHER LOOP KEYCHAIN
2861615 | \$14.99



KEYCHAIN
2861614 | \$6.99



KICKBACK ROCKER
2862626 | \$55.00



FREESTYLE ROCKER
2862625 | \$65.00



EASY CHAIR
2862627 | \$45.00



QUICK-E-SEAT
2862624 | \$35.00



FOLDABLE TABLE
2861620 | \$49.99



POP-UP TRASH BIN
2861622 | \$19.99



FLASK
2860812 | \$24.99



DECK OF CARDS
2860816 | \$14.99

OGIO

LEARN ABOUT OUR LINE OF OGIO® BAGS ONLINE AT
GENERAL.POLARIS.COM/OGIOLUGGAGE



FIND YOUR NEXT ADVENTURE



BUILD THE MACHINE TO TAKE YOU THERE

Customize your GENERAL with exactly what you need to ride comfortably and explore farther than you've ever gone before.



STEP 1
CHOOSE MODEL



STEP 2
CHOOSE TRIM

STEP 3
CHOOSE COLOR

STEP 4 CHOOSE ACCESSORIES

EXPERIENCE OFF-ROAD LUXURY

- Windshield & Rear Panel P. 08
- Doors P. 10
- Roof P. 12
- Cab Comfort P. 17

NEXT LEVEL VERSATILITY

- Storage P. 14
- Lighting P. 26
- Wheels & Tires P. 28
- Winches P. 36

THE RIGHT STUFF TO MAINTAIN YOUR GENERAL

- Maintenance P. 38
- Oil & Lubricants P. 40

EVERYTHING YOU NEED TO GEAR UP

- Apparel P. 58
- Helmets P. 60

**BUILD YOUR OWN AT
POLARIS.COM/GENERAL**

Warning: Polaris off-road vehicles can be hazardous to operate and are not intended for on-road use. Driver must be at least 16 years old with a valid driver's license to operate. All riders should always wear helmets, eye protection and protective clothing and footwear. Read, understand and follow your owner's manual. Ride within the limits of your own abilities and never engage in stunt or exhibition driving. Never ride under the influence of drugs or alcohol. All riders should take a safety training course. Call 800-342-3764 for additional information.
UNLESS NOTED, TRADEMARKS ARE THE PROPERTY OF POLARIS INDUSTRIES INC. 3M® and Thinsulate® are registered trademarks of 3M Company. 509® is a registered trademark of Teton Outfitters, LLC. Apple® and App Store® are a registered trademarks of Apple Inc. Bluetooth® is a registered trademark of Bluetooth SIG, Inc. Caliber® is a registered trademark of Caliber, Inc. Camoplast™ is a service trademark of Camso Inc. Facebook™ is a service trademark of Facebook, Inc. Fidlock® is a registered trademark of Fidlock GmbH. FOX® is a registered trademark of Fox Factory Inc. Google Play™ and YouTube® are registered trademarks of GOOGLE LLC. GoPro® is a registered trademark of GoPro, Inc. Instagram™ is a service trademark of Instagram, LLC. Kolpin® is a registered trademark of Polaris Industries Inc. Maxxis® is a registered trademark of Cheng-Shin Rubber Ind. Co., Ltd. MORFLEX® is a registered trademark of FNA Group, Inc. NOCO Genius® is a registered trademark of The Noco Company. Pandora® is a registered trademark of Pandora Media, LLC. Polartec® is a registered trademark of MMI-IPCO, LLC. RHINO-RACK® is a registered trademark of Rhino Rack Australia Pty Limited. RIGID® is a trademark of JST Performance, LLC d/b/a Rigid Industries LLC. Rockford Fosgate® is a registered trademark of Rockford Corporation. SMART BOARD® is a registered trademark of SMART TECHNOLOGIES ULC UNLIMITED LIABILITY CORPORATION CANADA. TEKVEST® is a registered trademark of 1181676 ONTARIO INC. Tiger Drylac® is a registered trademark of TIGER COATINGS GMBH & CO. Twitter™ is a registered trademark of Twitter, Inc. WALKER EVANS RACING® is a registered trademark of Walker Evans Enterprises Incorporated. Yeti® is a registered trademark of Yeti Coolers, LLC. YKK® is a registered trademark of YKK Corporation. Prices, Fitment and Availability are subject to change at any moment. Copyright © 2022 Polaris Industries Inc. All rights reserved.

UNLOCK MORE ADVENTURE

GET THE BEST OWNER EXPERIENCE OUT THERE

Our goal is to make every day of ownership a smooth ride. Sign in for access to everything you need, plus exclusive offers and more.

[OFFROAD.POLARIS.COM/ACCOUNT](https://offroad.polaris.com/account)



MY GARAGE

- Vehicle Profile & Accessory Details
- Maintenance Schedules
- Schedule Service
- Manuals & Warranty Info



MY RIDES & COMMUNITY

- My Tracked Rides
- My Planned Routes & POIs
- My Community Activities & Events
- Explore Polaris Adventures



MY SHOPPING

- Recommended Accessories
- Purchase History
- My Dealer
- Access to Polaris Pros



CONNECT ONLINE
SEARCH "PolarisORV"



BUILD YOUR DREAM MACHINE & EXPLORE FARTHER

1 CHOOSE
MODEL

2 CHOOSE
TRIM

3 CHOOSE
COLOR

4 CHOOSE
ACCESSORIES



VISIT [POLARIS.COM/GENERAL](https://polaris.com/general)
TO SEE VEHICLE OPTIONS AND VIEW ACCESSORIES
ON YOUR NEW MACHINE FROM EVERY ANGLE!

POLARIS
Think Outside